

| CADRO

CADRO

| Lighting elements



MINI LED STICK SPOTLIGHT

45078.0170.4001

12 V, 3 W, 4000 K,
aluminium, black super matt,
incl. 1.5 m cable + mini AMP plug

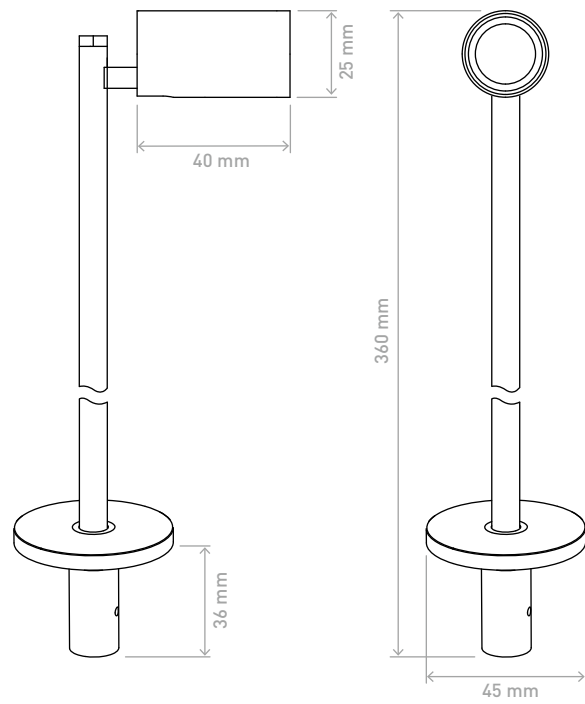

MINI LED RECESSED SPOTLIGHT

45077.0170.4001

12 V, 3 W, 4000 K,
aluminium, black super matt,
incl. 1.5 m cable + mini AMP plug

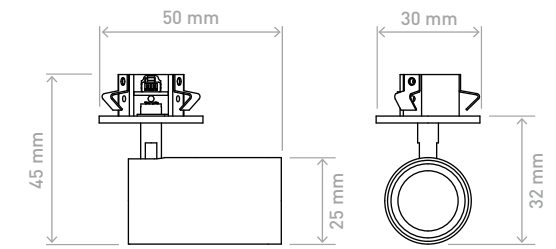

ROUND CONDUCTOR RAIL

45079.0170

12 V, 3 m, aluminium, black super matt

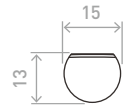

TOP-MOUNTED CONDUCTOR RAIL

45080.0170

12 V, 3 m, aluminium, black super matt

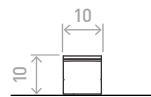

RECESSED CONDUCTOR RAIL

45081.0170

12 V, 3 m, aluminium, black super matt

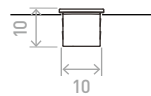

APPLICATION POSSIBILITIES



VERTICAL
45079.0170

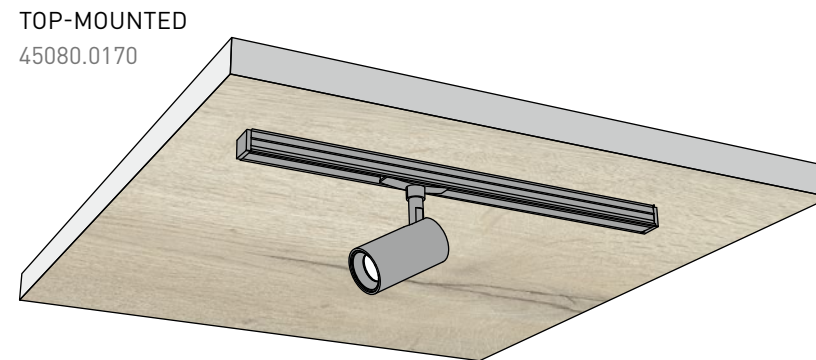

TOP-MOUNTED
45080.0170

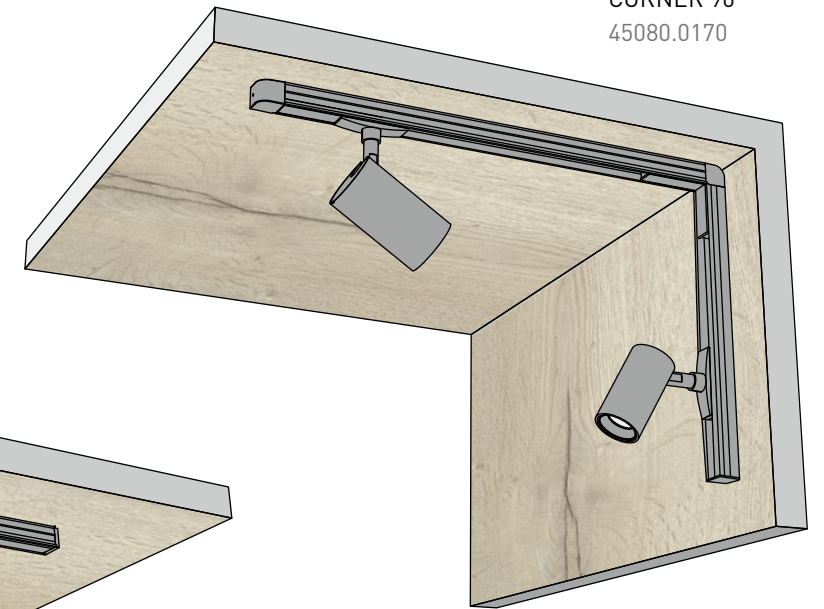

TOP-MOUNTED
CORNER 90°
45080.0170

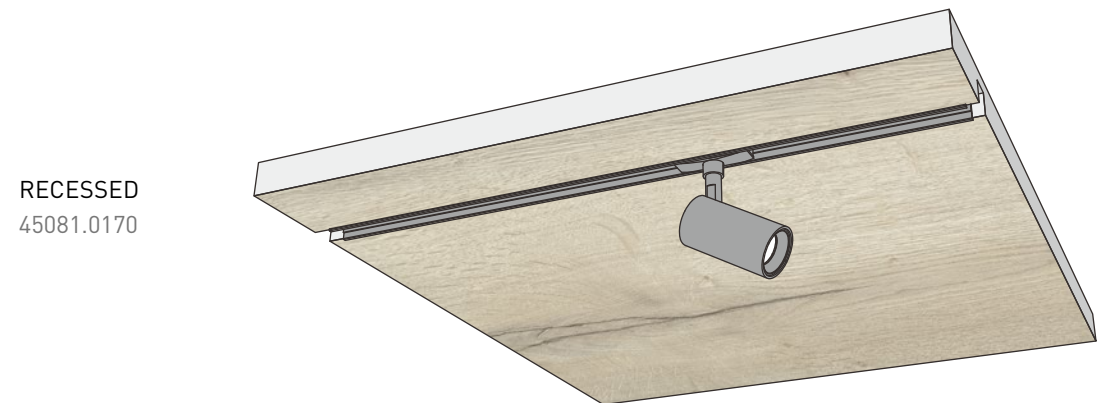

RECESSED
45081.0170

DIFFUSOR PROFILE

45086.0000

3 m, plastic, opal white



COVER PROFILE

45087.0001

3 m, plastic, black matt



ACCESS CABLE

45089.0000

1.5 m, black,
incl. mini AMP plug



All conductor rails are electrified by connecting the access cable. So spots can be plugged into the profiles at any point. In addition, the access also serves as a connection for LED lighting strips, which can be glued into the lighting profiles for area lighting.

MINI LED SPOTLIGHT 1W

45075.0170.3001

12 V, 1 W, 80 lm, 3000 K,
aluminium/plastic, black super matt,
for plugging into conductor rails

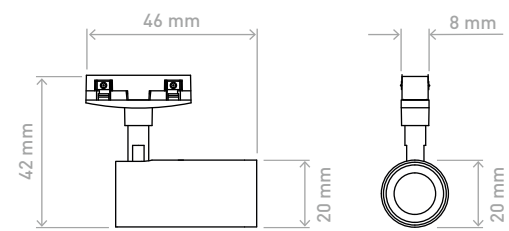

MINI LED SPOTLIGHT 3W

45076.0170.3001

12 V, 3 W, 240 lm, 3000 K,
aluminium/plastic, black super matt,
for plugging into conductor rails

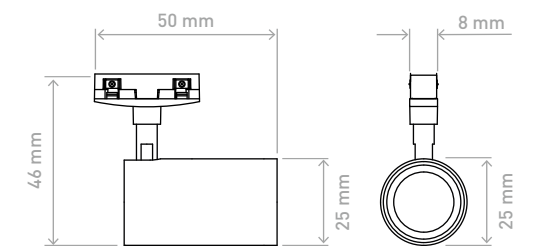
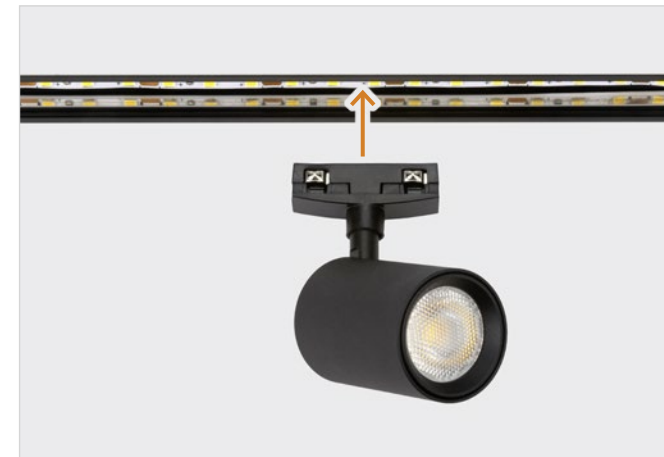

SOCKET HOLDER FOR ROUND CONDUCTOR RAIL

45085.0170

Aluminium,
black super matt

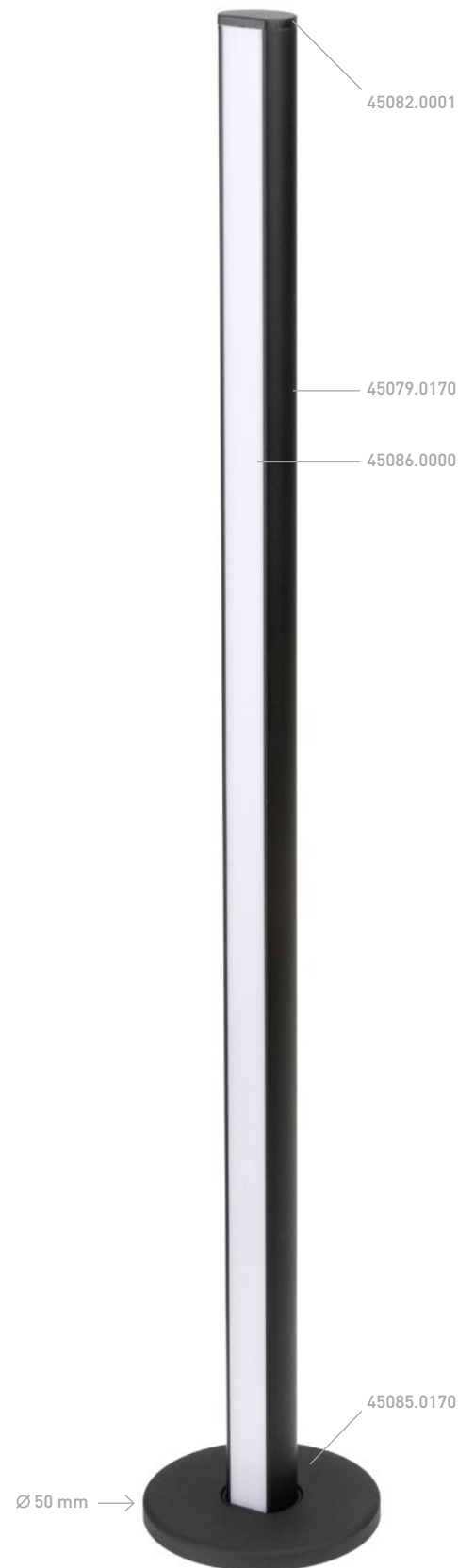

END CAP FOR ROUND CONDUCTOR RAIL

45082.0001

Plastic,
black super matt



END CAP FOR RECESSED CONDUCTOR RAIL

45083.0001

Plastic,
black super matt

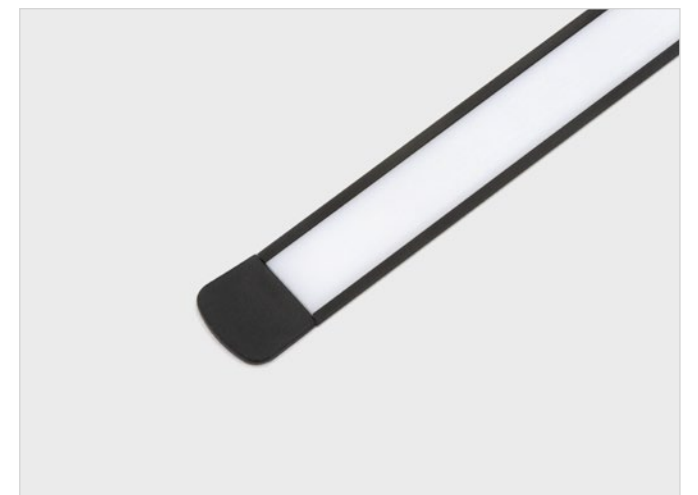

SET OF END CAPS FOR TOP-MOUNTED CONDUCTOR RAIL

45084.0001

Plastic,
black super matt



SET OF 2 MOUNTING CLIPS FOR TOP-MOUNTED CONDUCTOR RAIL

45088.0000

Metal



CORNER CONNECTOR

45091.0001

Plastic,
black super matt



CONNECTING CABLE

45090.0000

70 mm, black



SMD LIGHTING STRIP 4,8 W

45092.3001

12 V, 4.8 W/m, 60 LED/m,
warm white 3000 K,
5 mm x 5 m



SMD LIGHTING STRIP 9,6 W

45093.3001

12 V, 9.6 W/m, 120 LED/m,
warm white 3000 K,
5 mm x 5 m













SMD LIGHTING STRIP 5 W

45094.2760











12 V, 5 W/m, 152 LED/m,
2700 - 6000 K,
5 mm x 5 m



CADRO | Lighting elements - at a glance

	Art. No.	Description	PU
	45075.0170.3001	MINI LED SPOTLIGHT 1W 12 V, 1 W, 80 lm, 3000 K, aluminium/plastic, black super matt, for plugging into conductor rails	10
	45076.0170.3001	MINI LED SPOTLIGHT 3W 12 V, 3 W, 240 lm, 3000 K, aluminium/plastic, black super matt, for plugging into conductor rails	10
	45077.0170.4001	MINI LED RECESSED SPOTLIGHT 12 V, 3 W, 4000 K, aluminium, black super matt, incl. 1.5 m cable + mini AMP plug	10
	45078.0170.4001	MINI LED STICK SPOTLIGHT 12 V, 3 W, 4000 K, aluminium, black super matt, incl. 1.5 m cable + mini AMP plug	10
	45079.0170	ROUND CONDUCTOR RAIL 12 V, 3 m, aluminium, black super matt	10
	45080.0170	TOP-MOUNTED CONDUCTOR RAIL 12 V, 3 m, aluminium, black super matt	10
	45081.0170	RECESSED CONDUCTOR RAIL 12 V, 3 m, aluminium, black super matt	10
	45082.0001	END CAP FOR ROUND CONDUCTOR RAIL Plastic, black super matt	100
	45083.0001	END CAP FOR RECESSED CONDUCTOR RAIL Plastic, black super matt	100
	45084.0001	END CAPS FOR TOP-MOUNTED CONDUCTOR RAIL, 1 SET= 2 PIECES Plastic, black super matt	100

CADRO | Lighting elements - at a glance

	Art. No.	Description	PU
	45085.0170	SOCKET HOLDER FOR ROUND CONDUCTOR RAIL Aluminium, black super matt	10
	45086.0000	DIFFUSOR PROFILE 3 m, plastic, opal white	10
	45087.0001	COVER PROFILE 3 m, plastic, matt black	10
	45088.0000	MOUNTING CLIPS FOR TOP-MOUNTED CONDUCTOR RAIL, 1 SET=2 PIECES Metal	100
	45089.0000	ACCESS CABLE 1.5 m, black, incl. mini AMP plug	10
	45090.0000	CONNECTING CABLE 70 mm, black	10
	45091.0001	CORNER CONNECTOR Plastic, black super matt	100
	45092.3001	SMD LIGHTING STRIP 4.8W 112 V, 4.8 W/m, 60 LED/m, warm white 3000 K, 5 mm x 5 m	5
	45093.3001	SMD LIGHTING STRIP 9.6W 12 V, 9.6 W/m, 120 LED/m, warm white 3000 K, 5 mm x 5 m	5
	45094.2760	SMD LIGHTING STRIP 5W 12 V, 5 W/m, 152 LED/m, 2700 - 6000 K, 5 mm x 5 m	5

