

I desklife



confurn

living solutions



customer orientation



flexibility



team dynamics



personal comfort

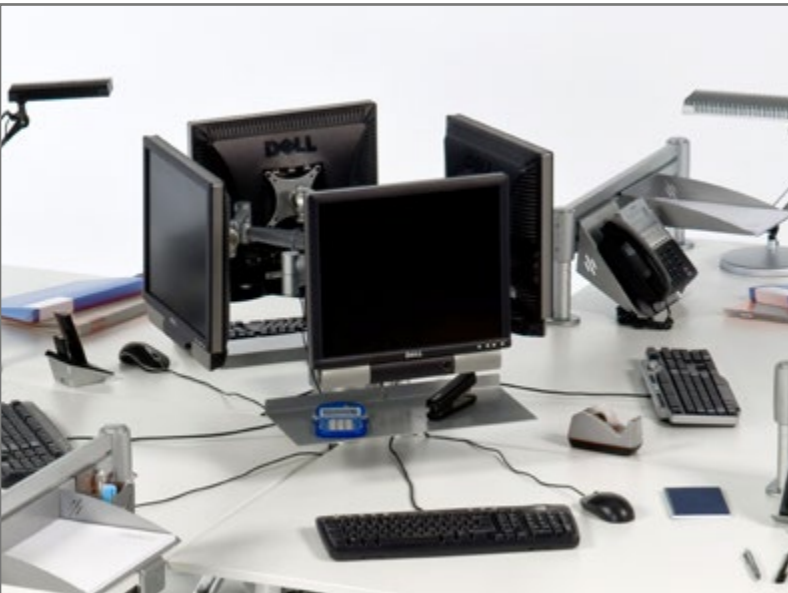

space saving



security

shape your own office

Support system SOLO

Modern design and diversity



Support post:

The elegant aluminium support post can be provided in 3 standard heights according to your application. 230, 400 or 800 mm. Every post has at least 1 silicon ring for the height adjustment of the monitor.



Fixing methods:

Depending on your personal set up requirements you can choose between 3 different fixing methods.



Each one of them offers you a maximum of comfort and security for your individual needs.



The cable outlet (1) with a drilling diameter of 80 mm does not only stand out with its superior look but also solves your cable problems (min. desktop thickness 18 mm).

Our round fitting (2) shows simplicity in design and requires only a 12 mm drilling hole through the desktop.

Our side clamp (3) is very user friendly and can be easily mounted from any table side without any drilling or screws (max. desktop thickness 40 mm).



Stylish and useful

Height adjustment:

To avoid unnecessary back problems while working in the office it is important that your monitor is in the right position to your eyes. That is why the height adjustment of the monitor according to your very own personal needs is very important.

The silicon ring on the support post makes the height adjustment very easy. Simply lift up the monitor with one hand, then push the silicon ring to your desired position with the other hand and put the monitor back on the ring.



Healthy work environment



Monitor support SOLO:

Long arm

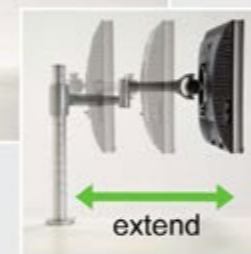

Max load capacity: 25 kg
Max extendibility: 400 mm



Short arm

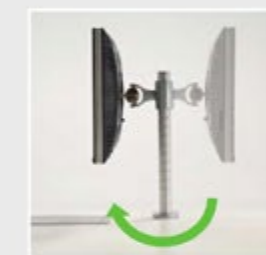

Free rotation and adjustment
VESA Standard mount 75/100 mm

More diversity:

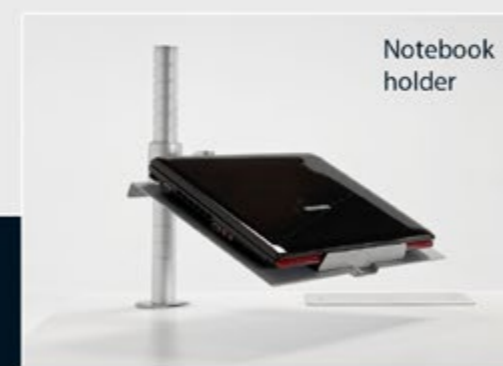

Use your laptop correctly.
Avoid back problems.

Enjoy even more diversity with our notebook holder and keyboard holder. Both of them are fully adjustable and provide the same comfort as our other support systems.



Use the space under your screen.

Support system QUATRO

Intelligent solutions



Support post:

The QUATRO aluminium support post can also be provided in 3 standard heights according to your application. 230, 400 or 800 mm. Every post comes with a black silicon ring, one cable clamp to hold the monitor cables and a silver plastic cover to give the aluminium post an elegant finish on the top.

Fixing methods:

According to your individual set up requirements you have the choice to use one of the 3 standard fixing systems.

1. Cable outlet fixing
2. Fixing with the round fitting
3. Side clamp fixing

Height adjustment:

For simple set ups with one monitor arm on the QUATRO post only, you can benefit from the same advantages that the silicon ring has to offer. Simply push the silicon ring to the desired height position and slide the monitor arm down on the ring.

For more complex monitor arm set ups with 2 or more arms on one QUATRO post you can use the four slots on the post. Each slot gives you the possibility to fix monitor arms.



So in one height of the QUATRO post you can put 4 monitor arms. This set up is especially useful for users that require more than one monitor to work. Email communication, internet and projects can be worked on at the same time without having to change the windows on one screen all the time.

To adjust the height of the monitor arm in the QUATRO post slot you just need to loosen the two black plastic wing nuts on the monitor arm (1&2) and then slide the arm to the required height position (3). This height adjustment offers barrier-free positioning. Various monitor arms can be adjusted to different heights on one QUATRO post to fulfill all your personal needs.

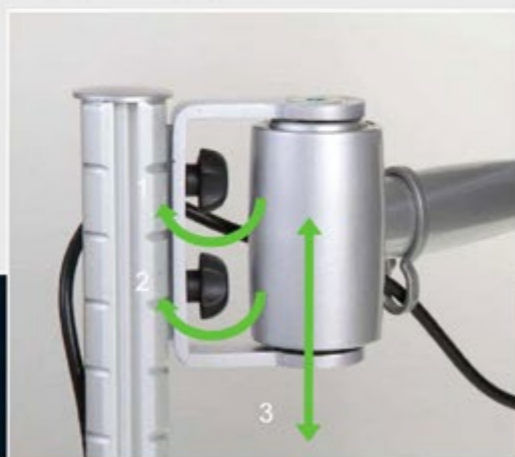

Maximising space availability



Monitor support QUATRO:

Long arm

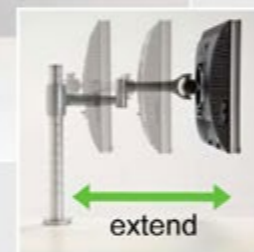

load

extend

Max load capacity: 25 kg

Max extendibility: 400 mm



Short arm



> 180°

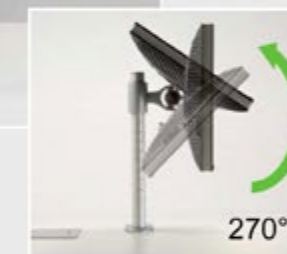

270°

Free rotation and adjustment

VESA Standard mount 75/100 mm

More diversity:

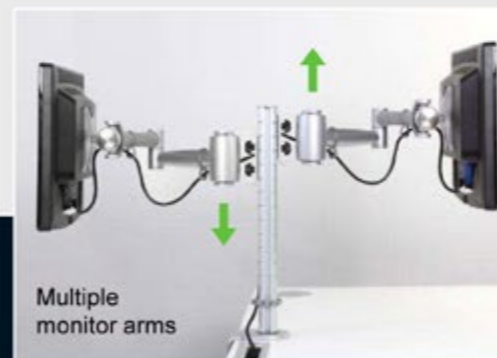

Multiple monitor arms

Email, internet and individual projects all in one sight.

The intelligent slot fixing system offers you various set up situations. Multiple monitor arms on one post or monitor arms that can use the full width of your desk partition are only two examples of what you can achieve with the QUATRO system.



Partition arm

Maximise your available space.

Functional design



Reinvent your desk:

The highly functional aluminium partition wall profile creates the extra amount of space that you need. It is flexible in length and can easily be adjusted in height on the support posts.

By using one or more partition wall profiles you can have more levels on your desk to temporarily store important documents, daily used stationary or any other personal material that you have on your desk.

By simply hanging the partition wall accessories into the aluminium section profile you can reinvent your desk. Our wide variety offers you just the right choice.

Convincing advantages once applied

 A4 document tray • portrait	 A4 document tray • landscape	 Pen holder single	 Pen holder triple on request only
 Telephone holder on request only	 Note holder	 Photo holder on request only	 CD rack on request only



Creating privacy

Partition walls:

The trend of modern office design often goes to open offices that support team work environment and easy communication. Yet not every job field allows this kind of office concept.

For workstation shapes that require more privacy or must be more space saving we have the appropriate accessory to follow that request.

The aluminium section profile can also be used to hold a partition wall of up to 8 mm thickness.

With its advanced design it can be used from both sides of the table to store your individual desk items.



Of course you can also use only our partition wall brackets and create a nice partition wall without the aluminium section.

A more intelligent way of saving space

Reliable functionality



design idea

CPU holders:

Being the centre piece of every PC the CPU requires the right protection in any application.

The fully adjustable DESKLIFE CPU supports are the ideal holding devices for every PC housing.

There are two assembly possibilities:

1. Fixing under the desktop.
2. Fixing to one side (up on an even area).



Safety in the office:

In order to comply with contemporary office safety requirements we have designed an extra feature that allows you to lock your CPU unit and protect all your important data with a few simple lock accessories.

These lock accessories are also fully adjustable to exactly match your individual CPU size.



Comfort and safety

World leading variety



Cable outlets:

Cables of keyboards, computer mouse, monitors or other devices on the desk can be really space taking and need to be managed to avoid cable tangle.

Being one of the global leaders in the variety of modern office desk cable outlets we can offer you just the perfect choice for your personal needs.

All our cable outlets are designed according to common industrial standards. Both plastic and metal cable outlets come with a diameter of 60 or 80 mm.

Brush feature:

To entirely hide the cables when passing through the desktop we have designed differently shaped brushes in the cable outlets.

Metal cable outlets

60 and 80 mm (with brush)



80 mm (with brush)



Flexible dimensions

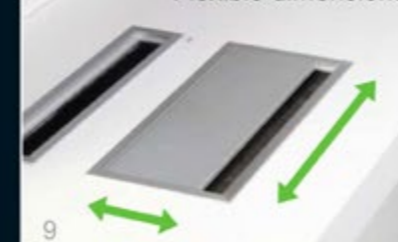

Plastic cable outlets

80 mm (with or without brush)



60 and 80 mm (with or without brush)



60 and 80 mm



Metal cable outlets

60 and 80 mm (with brush)



60 and 80 mm (with brush)



60 and 80 mm (with brush)



Cable channels:

Cable management doesn't stop under your desk. An excellent addition to the design of modern desks are our elegant cable channels, which can be mounted horizontally or vertically.

Aluminium outlets:

The square or rectangular shaped aluminium cable outlets satisfy contemporary design requirements. Being provided in various widths and lengths, with an antidust brush, with or without cover flap the cable outlets in this product range can be the solution for any cable management task.

Cable Management

Powerful solutions



Electrification unit:



80 mm (LAN, USB, 230V)



The fast evolving options of electronic accessories demand the right responses. Our multifunctional electrification unit provides all the necessary connections like USB, LAN, HDMI, Audio and one 230V power plug.



USB Hub cable outlets:

Use the USB Hub cable outlet to connect up to 4 devices directly to your computer or laptop. Your printer and external hard drive, your smartphone or just your memory stick, all in one place.

Simply dock on to the USB world.



60 mm (with 4 USB 2.0) or 80 mm (with 4 USB 2.0)



Cable management

Powerful solutions



Cable outlet with induction function:

Our high quality cable outlet made of metal with inductive charging function is characterized by its fine haptics and first class surface.

Whether minimalist or classically elegant, with its clear, timeless design, which is awarded the Red Dot Design Award and a large variety of available surfaces it fits perfectly into every piece of furniture.



- Wireless charging
- Induction & cable outlet
- Elegant and timeless design
- High quality through the use of metal
- Fine haptics and first class surfaces



reddot design award
winner 2017

Smarter ways to get connected

Content

- | | |
|--------------------------|---------|
| 1. Monitor support | page 15 |
| 2. Support systems | page 24 |
| 3. Partition accessories | page 27 |
| 4. CPU management | page 32 |
| 5. Cable management | page 34 |

Or visit us online and discover the variety of our products.



Monitor Support > Phoenix Series

www.desklife.de 

Monitor Support

Phoenix Series
SOLO post



"Phoenix" monitor holder - long arm

Load capacity: up to 25 kg (VESA mount 75 / 100 mm)
Extendibility: up to 400 mm

A) Long arm incl. support post and fixing system

Article No.	Support Post	Fixing System	Color
82332.8467	SOLO 400mm	cable outlet (1)	silver
82339.9867	SOLO 400mm	round fitting (2)	silver
82071.0067	SOLO 400mm	side clamp (3)	silver
82271.0067	SOLO 400mm	without	silver



B) Long arm only (Extendibility 400mm)

Article No.	Support Post	Color	Set incl.
82225.0067	for SOLO	silver	cable clips

C) Medium length arm only (Extendibility 300mm)

Article No.	Support Post	Color	Set incl.
82567.0067	for SOLO	silver	cable clips



"Phoenix" monitor holder - short arm

Load capacity: up to 25 kg (VESA mount 75 / 100 mm)
Arm length: 110 mm

A) Short arm incl. support post and fixing system

Article No.	Support Post	Fixing System	Color
82344.8467	SOLO 400mm	cable outlet (1)	silver
82345.9867	SOLO 400mm	round fitting (2)	silver
82138.0067	SOLO 400mm	side clamp (3)	silver
82331.0067	SOLO 400mm	without	silver



B) Short arm only

Article No.	Support Post	Color	Set incl.
82374.0067	for SOLO	silver	cable clip



LEGEND

SURFACES

Other surfaces on request

Monitor Support

Phoenix Series
QUATRO post



"Phoenix" monitor holder - long arm

Load capacity: up to 25 kg (VESA mount 75 / 100 mm)
Extendibility: up to 400 mm

A) Long arm incl. support post and fixing system

Article No.	Support Post	Fixing System	Color
82367.8467	QUATRO 400mm	cable outlet (1)	silver
82368.9867	QUATRO 400mm	round fitting (2)	silver
82369.0067	QUATRO 400mm	side clamp (3)	silver
82370.0067	QUATRO 400mm	without	silver



B) Long arm only (Extendibility 400mm)

Article No.	Support Post	Color	Set incl.
82476.0067	for QUATRO	silver	cable clips

C) Medium length arm only (Extendibility 300mm)

Article No.	Support Post	Color	Set incl.
82525.0067	for QUATRO	silver	cable clips

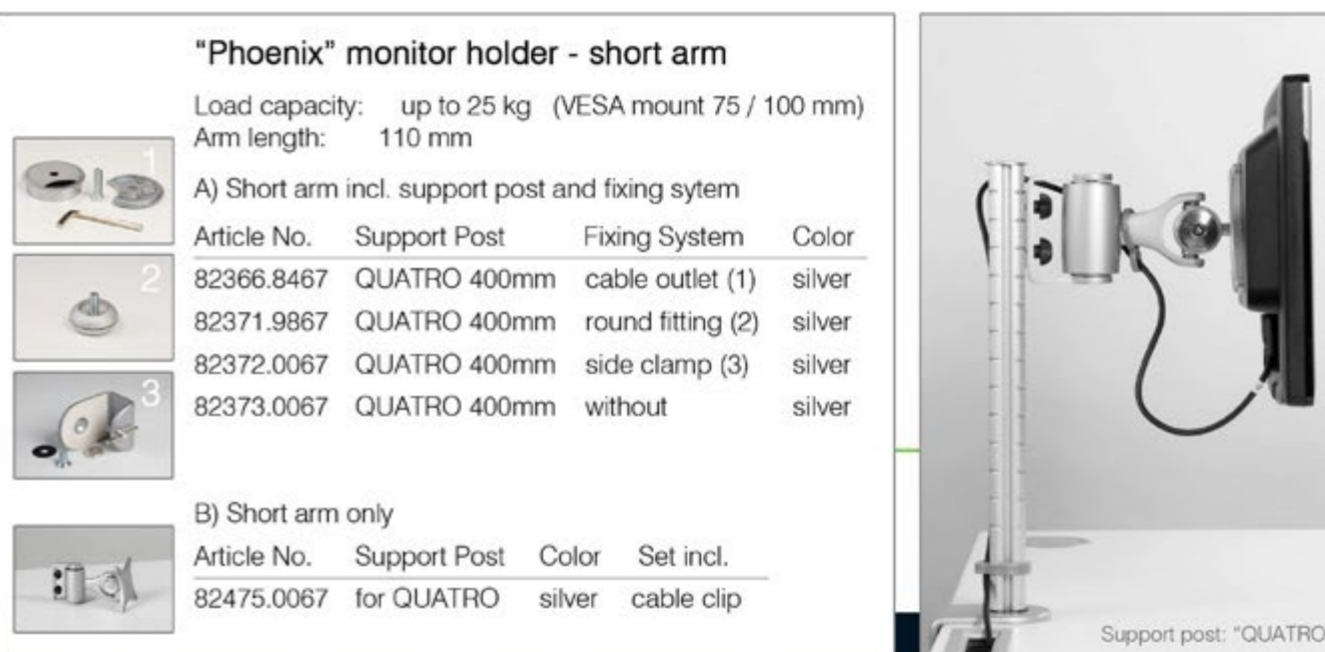

"Phoenix" monitor holder - short arm

Load capacity: up to 25 kg (VESA mount 75 / 100 mm)
Arm length: 110 mm

A) Short arm incl. support post and fixing system

Article No.	Support Post	Fixing System	Color
82366.8467	QUATRO 400mm	cable outlet (1)	silver
82371.9867	QUATRO 400mm	round fitting (2)	silver
82372.0067	QUATRO 400mm	side clamp (3)	silver
82373.0067	QUATRO 400mm	without	silver



B) Short arm only

Article No.	Support Post	Color	Set incl.
82475.0067	for QUATRO	silver	cable clip



LEGEND

SURFACES

Other surfaces available on request

Monitor Support

Phoenix Series
Partition arms



"Phoenix" monitor holder - partition wall

Load capacity: up to 25 kg (VESA mount 75 / 100 mm)
Short arm length: 110 mm

A) Short arm

Article No.	Color	Set incl.
82259.0067	silver	cable clip



Please check the Desklife partition wall accessories for details.



"Phoenix" monitor holder - partition wall

Load capacity: up to 25 kg (VESA mount 75 / 100 mm)
Long arm length: up to 400 mm

B) Long arm

Article No.	Color	Set incl.*
82375.0067	silver	cable clips



Please check the Desklife partition wall accessories for details.

LEGEND

SURFACES

Other surfaces on request

Further details:

Accessories

Every "Phoenix" monitor mounting plate (VESA standard) has an elegant ABS plastic back cover to hide the 4 screws and finish off your monitor just right from the back.

Additionally every "Phoenix" monitor arm set is including the necessary tools (e.g. allen keys) that are required for a set up.



The "Phoenix" long arms, medium length arms, short arms and the "Phoenix" partition wall arms are equipped with 3 different ABS plastic cable clips to hold the cables of the monitor.

The support post cable clip has the advantage of taking at least 4 cables with different diameters.



LEGEND

SURFACES

Other surfaces available on request



Monitor Support > Laptop Series

Monitor Support Laptop Series



Laptop holder

Suitable for the support posts "Solo" & "Quatro"
Load capacity: up to 8 kg
Laptop sizes: max. W 400 x D 300



Article No.	Application	Color	
82324.0067	support post	silver	1 set incl. arm (1)
82376.0067	partition wall	silver	1 set incl. arm (2)



Application 1: Monitor support post

Put the laptop holder on the Desklife support post "Solo" or "Quatro".



Enjoy the comfort of being able to adjust your laptop screen to the right ergonomic position to your eyes. All you need is an extra keyboard.



Application 2: Partition wall profile

It is also possible to put the laptop holder on your partition wall.



Simply hang the laptop holder bracket at the desired position into the partition wall profile (left or right) and adjust the height of your screen by either putting the partition wall up or down on the support posts or by flapping the metal tray up or down.



Further applications

Lock your laptop with our Desklife notebook locks and feel safe during your lunch break.

Article No.	Length	Color	
82245.0000	2m	silver	1 set



LEGEND

Packing Unit

SURFACES

Other surfaces available on request



Monitor Support > Keyboard Series

Monitor Support Keyboard Series



Keyboard holder

Suitable for the support posts "SOLO" and "QUATRO"

Load capacity: up to 8 kg

Article No.	Material	Color	
82325.0067	steel	silver	1 set



Application 1: Monitor support post

Put the keyboard holder under your monitor on the Desklife support post "SOLO" or "QUATRO". Place your keyboard on the tray whenever you do not need it and enjoy the comfort of using that extra space on your desk for taking some notes or reading an interesting survey.



Application 2: Partition wall support post

It is also possible to put the keyboard holder on one of your partition wall support posts.

With its full rotatability the keyboard tray can even be used from both sides of the desk by you or your colleague working opposite your work station.



Further applications

Of course the keyboard holder can be used for any other stationary item.

Use it for anything you like.



LEGEND

 Packing Unit

SURFACES

Other surfaces on request



Support Systems

Support Systems Fixing Systems



Cable outlet fixing (desktop thickness min. 18mm)

ART.NO.	Material					
82189.8467	Zinc	18			80	20/1 (1)



Round fitting (12mm drilling hole)

ART.NO.	Material					
50046.0098	Alu	12			60	10/1 (2)



Side clamp (desktop thickness max. 40mm)

ART.NO.	Post					
82262.0067	SOLO	65	80	110		10/1 (3)
82539.0067	QUATRO	65	80	110		10/1 (4)



LEGEND

- Diameter
- Height
- Width
- Depth
- Packing Unit

SURFACES

- *****.8467 Chrome matt plated / silver painted
- *****.0067 Silver painted (RAL 9006)
- *****.0098 Aluminium anodized
- Other surfaces available on request

Support Systems Support Posts



Support post "SOLO"
Including plastic top cover (A), silicone ring (B) and cable clip (C)

With cable outlet fixing (1):

Post height:	230mm height	400mm height	800mm height
Article No:	82349.8467	82352.8467	82354.8467

With round fitting (2):

Post height:	230mm height	400mm height	800mm height
Article No:	82350.9867	82353.9867	82355.9867

With side clamp (3):

Post height:	230mm height	400mm height	800mm height
Article No:	82351.0067	82191.0067	82356.0067

Without fixing system:

Post height:	230mm height	400mm height	800mm height
Article No:	82312.0067	82224.0067	82313.0067

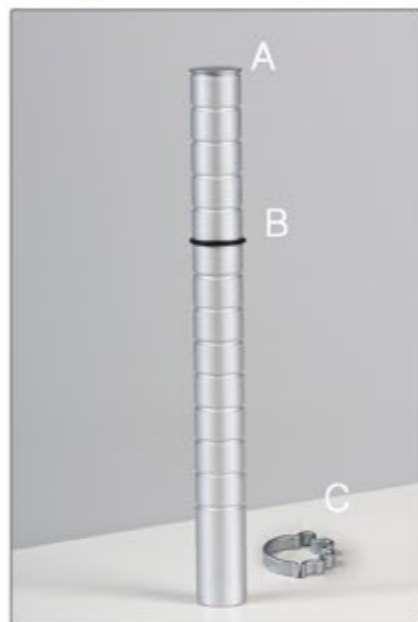

Support post "QUATRO"
Including plastic top cover (A), silicone ring (B) and cable clip (C)

With cable outlet fixing (1):

Post height:	230mm height	400mm height	800mm height
Article No:	82380.8467	82381.8467	82382.8467

With round fitting (2):

Post height:	230mm height	400mm height	800mm height
Article No:	82383.9867	82384.9867	82385.9867

With side clamp (4):

Post height:	230mm height	400mm height	800mm height
Article No:	82386.0067	82387.0067	82388.0067

Without fixing system:

Post height:	230mm height	400mm height	800mm height
Article No:	82377.0067	82378.0067	82379.0067

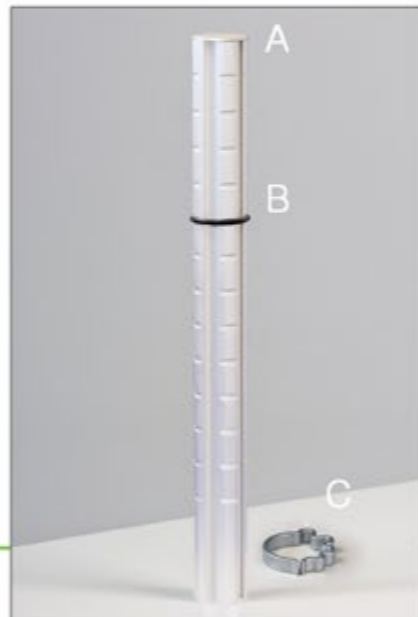

Partition Accessories



LEGEND
SURFACES
Aluminium anodized

Partition Accessories
Support System

Aluminium partition wall profile

Article No.	Color	Length
82258.0098	silver	3000mm

Other lengths on request



Aluminium profile brackets for "SOLO"

Article No.	Color	Material	Set incl.
82257.0067	silver	Zinc	2 brackets 4 screws M5 2 silicon rings 4 screws M6



Aluminium profile brackets for "QUATRO"

Article No.	Color	Material	Set incl.
82389.0000	black	PA6 GF30	2 brackets 4 screws M5 1 allen key 2 gliding cap



Aluminium profile cover profile (plastic)

Article No.	Color	Material	Length
82260.0000	silver	PS	3000mm

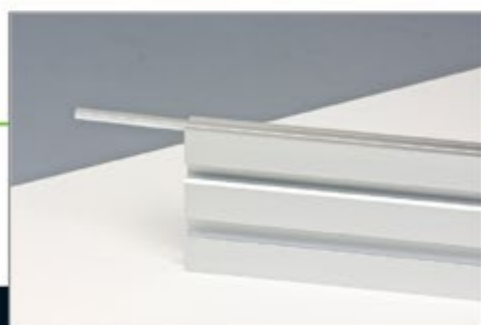

LEGEND

SURFACES

As mentioned above

Partition Accessories
Partition Storage



A4 Document Tray (portrait)

ART.NO.	Color	Height	Width	Depth	Ø	Packing Unit
82314.0093	silver	64	220	300		1



A4 Document Tray (landscape)

ART.NO.	Color	Height	Width	Depth	Ø	Packing Unit
82315.0093	silver	62	300	230		1



Pencil Box (single)

ART.NO.	Color	Height	Width	Depth	Ø	Packing Unit
82316.0093	silver	100	72	70		1



Pencil Box (triple)

ART.NO.	Color	Height	Width	Depth	Ø	Packing Unit
82317.0093	silver	100	216	70		1



On request only

LEGEND

SURFACES

- Diameter
- Height
- Width
- Depth
- Packing Unit

Silver painted

Partition Accessories
Partition Storage



Telephone Holder

ART.-NO.	Color					
82318.0093	silver	100	200	240		1



Notes Holder

ART.-NO.	Color					
82319.0093	silver	99	110	110		1



Picture Holder

ART.-NO.	Color					
82320.0093	silver	107	152	10		1



CD Rack

ART.-NO.	Color					
82321.0093	silver	79	143	133		1



- LEGEND**
- Diameter
 - Height
 - Width
 - Depth
 - Packing Unit
- SURFACES**
- Silver painted

Partition Accessories
Partition Walls



Partition wall holder (single)

Article No.	Color	
82139.0067	silver	1



Partition wall holder (double in line)

Article No.	Color	
82186.0067	silver	1



Partition wall holder (double 90° angle)

Article No.	Color	
82256.0067	silver	1



Partition wall holder (triple)

Article No.	Color	
82187.0067	silver	1



Covers (A) and Screw (B)

Article No.	Color	Set incl.
82185.0067	silver	2 pcs covers 1 screw

Suitable for all wall holders on this page



- LEGEND**
-
- SURFACES**
- Silver painted
 - Other colors on request



CPU Management

CPU Management CPU Holders







CPU Holder Standard

ART.-NO.	Color					
80025.0059	silver	370-630	85-230			1
80025.0001	black	370-630	85-230			1



CPU Holder with side cover

ART.-NO.	Color					
On request	silver	370-630	85-230			1
On request	black	370-630	85-230			1



CPU Holder Lock Unit Kit

Article No.	Color	
80932.0059	silver	6/1
80932.0001	black	6/1



LEGEND

-  Diameter
-  Height
-  Width
-  Depth
-  Packing Unit

SURFACES





Standard silver or black



Cable Management



Cable Management Metal Cable Outlets



ART.-NO.	Mat.					
82067.****	Zinc	22	120	90	80	8
82236.****	Zinc	22	93	70	60	12



* with brush



ART.-NO.	Mat.			
82068.****	Zinc	22	80	8
82190.****	Zinc	13	80	8
82233.****	Zinc	22	60	12



* with brush



ART.-NO.	Mat.			
82017.****	Zinc	22	60	12
20084.****	Zinc	22	80	8

* with brush



ART.-NO.	Mat.			
82337.****	Zinc	13	60	12
82338.****	Zinc	13	80	8

* with brush



LEGEND

-  Diameter
-  Height
-  Width
-  Depth
-  Packing Unit

SURFACES

- ****.0014 Chrome gloss plated
- ****.0084 Chrome matt plated
- ****.0085 Brushed stainless steel plated
- ****.0067 Silver painted (RAL 9006)
- Other surfaces available on request

Cable Management
Metal Cable Outlets



ART.NO.	Mat.					
82398.****	Zinc	13 **	90	90	80	12
82661.****	Zinc	13	70	70	60	45
82662.****	Zinc	22	70	70	60	

* with brush ** mounting height 19mm and 25mm on demand



Cable Management
Plastic Cable Outlets



ART.NO.	Mat			
20130.****	ABS	6	80	200
20080.****	ABS	13	80	150
20113.****	ABS	19	80	100
20011.****	ABS	22	80	100



ART.NO.	Mat			
20128.****	ABS	6	60	500
20122.****	ABS	10	60	200
20009.****	ABS	16	60	250
20006.****	ABS	22	60	200



ART.NO.	Mat			
82146.****	ABS	22	80	100

* with brush



ART.NO.	Mat			
82148.****	ABS	22	80	100



LEGEND

- Diameter
- Height
- Width
- Depth
- Packing Unit

SURFACES

- ****.0014 Chrome gloss plated
 - ****.0084 Chrome matt plated
 - ****.0085 Brushed stainless steel plated
 - ****.0067 Silver painted (RAL 9006)
- Other surfaces available on request

LEGEND

- Diameter
- Height
- Width
- Depth
- Packing Unit

SURFACES

- ****.0001 Black
 - ****.0002 White
 - ****.0007 Light grey
 - ****.0067 Silver painted (RAL 9006)
- Other surfaces available on request

Cable Management
Plastic Cable Outlets



ART.-NO.	Mat			
82075.****	ABS	22	80	100
82072.****	ABS	22	60	200



ART.-NO.	Mat			
82144.****	ABS	22	80	100
82142.****	ABS	22	60	200

* with brush



ART.-NO.	Mat				
20185.****	ABS	22	80	100	90



ART.-NO.	Mat				
20030.****	ABS	25	74	150	68



LEGEND

- Diameter
- Height
- Width
- Depth
- Packing unit

SURFACES

- ****.0001 Black
- ****.0002 White
- ****.0007 Light grey
- ****.0067 Silver painted (RAL 9006)
- Other surfaces available on request

Cable Management
Cable Outlets

Technical Specifications

All **Desklife** metal and plastic cable outlets have an outer ring diameter of either 60mm or 80mm.

Each cable outlet ring has 12 ribs on the outside of the ring (see below detailed drawing). The outer dimension measured over the ribs is a little bit larger than the hole in the desktop. These ribs are used to ensure a tight fit and do not allow the ring to be turned in your desktop.

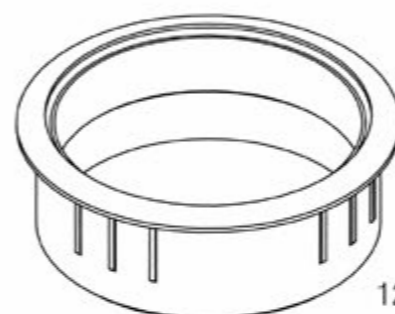

12 ribs

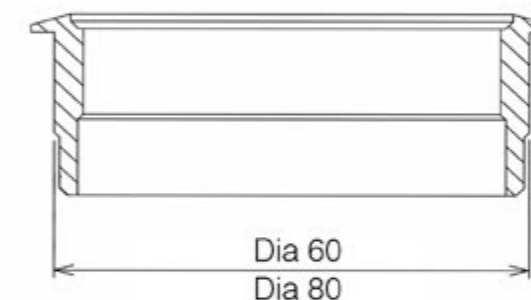

Desktop Drilling Instructions

For the dia 80mm cable outlets please drill a hole of 80.00 mm in the desktop.
For the dia 60mm cable outlets please drill a hole of 60.00 mm in the desktop.

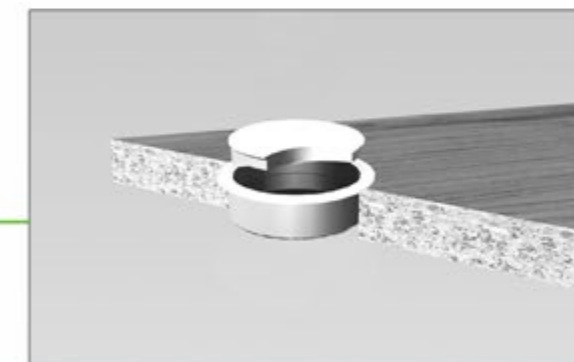
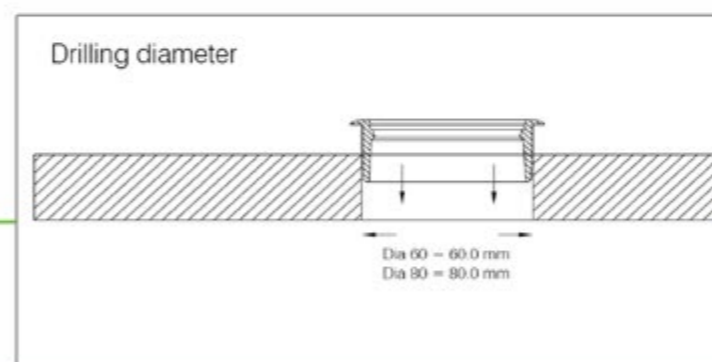

CONTACT

confurn | Sundernkämpe 14 | D-32549 Bad Oeynhausen | Germany
Fon: +49-5734-96 09-0 | Fax: +49-5734-96 09-82
info@confurn.de | www.desklife.de | www.confurn.eu

Cable Management Aluminium Cable Outlets



ART.-NO.	Color	Mat.				
82596.0098	silver	Alu	25	70	120	1
82517.0098	silver	Alu	25	280	120	1
82627.0098	silver	Alu	25	300	120	1
82990.0098	silver	Alu	25	360	120	1
82668.0098	silver	Alu	25	450	120	1

* with brush



ART.-NO.	Color	Mat.				
82596.0198	silver	Alu	25	70	120	1
82517.0198	silver	Alu	25	280	120	1
82627.0198	silver	Alu	25	300	120	1
82990.0198	silver	Alu	25	360	120	1
82668.0198	silver	Alu	25	450	120	1

* with brush

* with spring mechanism



ART.-NO.	Color	Mat.				
82883.0198	silver	Alu	25	360	160	1
82882.0198	silver	Alu	25	450	160	1

* with brush

* with spring mechanism



Cable Management Aluminium Cable Outlets



ART.-NO.	Color	Mat.				
82628.0098	silver	Alu	25	200	100	1

* with brush

* available with spring mechanism on demand



ART.-NO.	Color	Mat.				
82584.0098	silver	Alu	25	70	70	1
82585.0098	silver	Alu	25	120	70	1
82619.0098	silver	Alu	25	200	70	1
82620.0098	silver	Alu	25	300	70	1
82587.0098	silver	Alu	25	350	70	1
82621.0098	silver	Alu	25	400	70	1
82622.0098	silver	Alu	25	600	70	1
82586.0098	silver	Alu	25	700	70	1

* with brush



ART.-NO.	Color	Mat.				
82623.0098	silver	Alu	25	200	53	1
82588.0098	silver	Alu	25	300	53	1
82625.0098	silver	Alu	25	400	53	1
82626.0098	silver	Alu	25	600	53	1

* with brush



LEGEND

- Diameter
- Height
- Width
- Depth
- Packing Unit

SURFACES

Other surfaces on demand

LEGEND





- Diameter
- Height
- width
- Depth
- Packing Unit

SURFACES

Other surfaces on demand

Cable Management Aluminium Cable Outlets



ART.-NO.	Color	Mat.				
82629.0098	silver	Alu	25	300	218	1
82629.0021	black	Alu	25	300	218	1
82629.0041	white	Alu	25	300	218	1
82629.0014	chrom	Alu	25	300	218	1

* with brush

DUPLEX cable exit

Smooth design, smart access

Easy double-sided access to power and data makes the Duplex cable exit a perfect accessory to a modern office furnishing. The cable exit offers in conjunction with a cable box room for up to 8 power, data and multimedia modules. Screw holes on the front sides guarantee an easy installation.

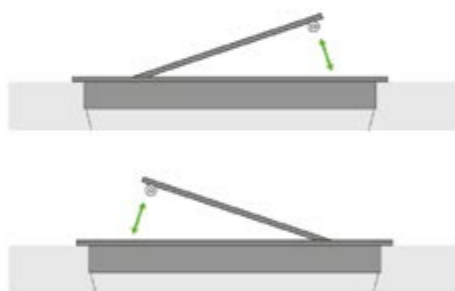

Double-sided access



Cable Management Aluminium Cable Outlets

Technical Specifications

All desklife aluminium cable outlets are made from high grade aluminium alloy to meet the high industrial standards.

A standard radius 8 in the table section cut out can be used for routing thanks to the cable outlet's specially processed corners. (see detail 3)

With a 4 x 15 self tapping chipboard screw the frame of the cable outlet can be fixed to the desktop. (see detail 1)

The integrated magnet in the frame can hold the cover of the cable outlet even in an up side down position. (see detail 4)

A specifically designed spring mechanism mounted on the left hand side allows to reduce the noise considerably when closing the lid. (see detail 5)

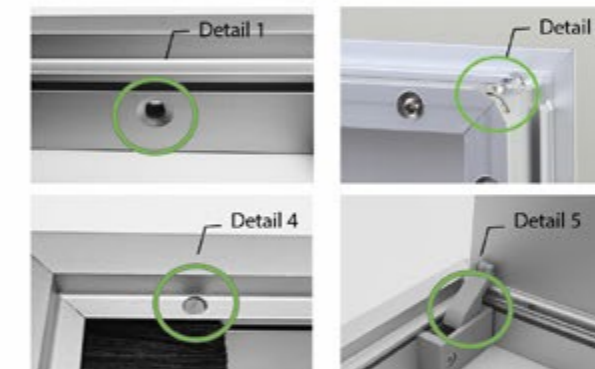
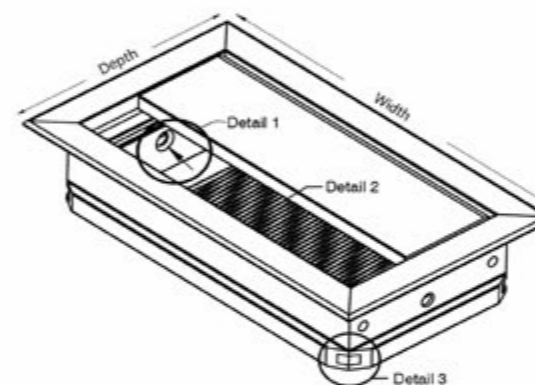

Detail 1: Screwhole for 4x15 mm hole
Detail 4: Magnet to hold cover

Detail 2: Brush to hide cables
Detail 3: Radius 8 for easy cut out
Detail 5: Spring mechanism (for width 100 mm upwards on demand)

Desktop Routing Instructions

Routing dimensions

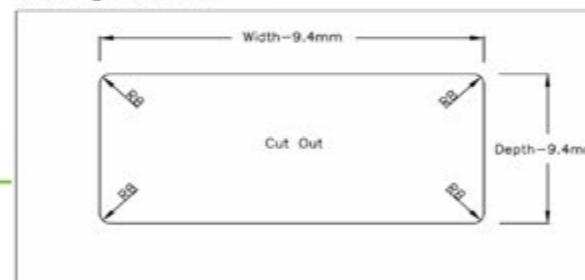

Cut out dimensions (mm)

Width	Cut out	Depth	Cut out
70	60,6	53	43,6
120	110,6	70	60,6
200	190,6	100	90,6
280	270,6	120	110,6
300	290,6	160	150,6
350	340,6		
360	350,6		
400	390,6		
450	440,6		
600	590,6		
700	690,6		

LEGEND

-  Diameter
-  Height
-  Width
-  Depth
-  Packing Unit

SURFACES

Other surfaces available on request

CONTACT

Cable Management
Power & Data Outlets



ART.-NO.	Color	Mat.			
82544.0001	black	ABS	22	60	1
82544.0067	silver	ABS	22	60	1
82562.0001	black	ABS	22	80	1
82562.0067	silver	ABS	22	80	1

Cable outlet with 4 USB 2.0 ports for **data transmission**.
Incl. USB extension cable (2m), with brush



ART.-NO.	Color	Mat.			
82786.0001	black	ABS	22	60	1
82786.0067	silver	ABS	22	60	1
82718.0001	black	ABS	22	80	1
82718.0067	silver	ABS	22	80	1

Cable outlet with 4 active USB 2.0 ports for **data transmission and power supply (charging function)**. Incl. USB extension cable (2m), power supply (1m), with brush



ART.-NO.	Color	Mat.				
82565.0184	chrome matt	ABS / Zinc	90	90	80	1

* Power socket supply cable with plug (2m), LAN (RJ45) and USB 2.0 data link



LEGEND

- Diameter
- Height
- Width
- Depth
- Packing Unit

SURFACES

- *****.0014 Chrome gloss plated
- *****.0084 Chrome matt plated
- *****.0085 Brushed stainless steel plated
- *****.0067 Silver painted (RAL 9006)
- Other surfaces available on request

Cable Management
Cable outlet with induction



ART.-NO.	Mat.				
82774.****	Zink	90	13	80	1

* Includes power supply with 2.5 m cable



ART.-NO.	Mat.				
82773.****	Zink	88,2	13	80	1

* Includes power supply with 2.5 m cable



ART.-NO.	Mat.	Color			
82813.0001	ABS	black	27,7	58,1	1

* Includes power supply with 2.5 m cable



LEGEND

- Diameter
- Height
- Width
- Depth
- Packing Unit

SURFACES

- *****.0014 glossy chrome
- *****.0084 mat chrome
- *****.0085 brushed stainless steel
- *****.0001 mat black painted
- *****.0002 white highglossy lacquered
- Other surfaces available on request

desklife



desklife | monitor

- Monitor arms



desklife | partition

- Partition wall management
- Partition wall accessories



desklife | CPU

- CPU holders



desklife | cable

- Plastic cable outlets
- Metal cable outlets
- Functional cable outlets