

| elements

Boating-, Caravan- and Motor-Home Equipment

Handle solutions | Functional Handles | Locking Systems



Überzeugend. Auf der ganzen Linie.

Convincing. In every aspect.

Convaincant. Sur toute la ligne.

Als kreativer, zuverlässiger Partner der Möbelindustrie bietet confurn viel mehr als Griffe, Knöpfe und Beschläge. confurn steht für innovative, maßgeschneiderte Lösungen von der Produktentwicklung über die wirtschaftliche Serienproduktion und optimale Qualitätssicherung bis hin zur termingerechten Lieferung. Sagen Sie uns, womit wir Sie überzeugen können. Wir freuen uns auf Ihre Herausforderung!

Being a creative and reliable partner to the furniture industry, confurn offers much more than just handles, knobs and fittings. confurn stands for innovative, customized solutions including all the processes from product development over commercial mass production and thorough quality assurance up to on-schedule deliveries. Simply let us know how we can convince you. We look forward to your challenge!

En tant que partenaire créatif et fiable de l'industrie du meuble, confurn offre bien plus que des poignées, des boutons et des ferrures. confurn est également synonyme de solutions innovantes et personnalisées allant du développement de produits en passant par la production à l'échelle commerciale combinée à une assurance qualité optimale jusqu'à une livraison fiable et ponctuelle. Dites-nous tout simplement comment nous pouvons vous convaincre. Nous relèverons le défi !



Erfolg aus Erfahrung und Ideen.

Success through experience and ideas.
Succès grâce à l'expérience et aux idées.

Seit mehr als 30 Jahren liefert confurn Beschläge und Komponenten für verschiedenste Anwendungsbereiche – ganz nach Bedarf sowohl in kleinsten Stückzahlen als auch in Großserien. Durch umfassende Marktkenntnis, immer neue Ideen und Know-how auf dem aktuellsten Stand, erfüllen unsere Mitarbeiter auch ganz spezielle Ansprüche absolut präzise.

confurn has been supplying fittings and components to several application fields for over 30 years – and this from customized unique pieces to serial production. Thanks to our rich and extensive experience within the furniture market, our continuous development of new ideas and the most up-to-date know-how, our staff is used to meet even special requirements with absolute precision.

Depuis plus de 30 ans confurn fournit des ferrures et des composants destinés à divers champs d'application en couvrant tous les besoins, de la fabrication à petites quantités jusqu'à la grande série. Grâce à de longues années d'expérience sur le marché de l'ameublement, de nouvelles idées continuellement développées et une expertise constamment renouvelée et actualisée, notre personnel est hautement qualifié pour répondre aux exigences particulières. Et cela de manière absolument précise.



Service und Logistik mit System.

Service and logistics with a system.
Service et solutions logistiques ayant du système.

Kundenorientiertes Denken geht für uns weit über das fertige Produkt hinaus. Ein leistungsfähiges Logistik- und Lagerhaltungssystem mit ausgewählten Zulieferern und Speditionspartnern, garantiert jederzeit und weltweit eine termingerechte und sichere Belieferung.

For us, customer-oriented thinking is much more than just the finished product. Our efficient logistics and inventory management system includes well chosen suppliers and forwarding partners. This guarantees fast and timely deliveries anywhere in the world.

Pour nous, la pensée orientée vers le client représente beaucoup plus que le produit fini. Nos systèmes logistiques et de stockage efficaces ainsi que la coopération avec des sous-traitants et des transporteurs bien choisis, garantissent une livraison rapide et fiable à tout moment et à chaque endroit dans le monde.



Qualität und Design nach Maß.

Custom-made quality and design.
Qualité et design sur mesure.

Die enge partnerschaftliche Zusammenarbeit mit unseren Kunden ermöglicht es uns, Wünsche und Markterfordernisse direkt in die Entwicklungs- und Fertigungsprozesse einfließen zu lassen. Antizipation von möglichen Schwachstellen, prozessbegleitende Überwachung von Vorgaben und strenge Endkontrollen gewährleisten bei allen Komponenten und Lösungen ein beispielhaft hohes Qualitäts- und Designniveau.

Due to the close cooperation with our customers we are able to directly integrate special requests and market requirements into the development and manufacturing processes. The anticipation of possible weak points, monitoring of process specifications as well as stringent final inspections allow us to achieve an exemplary high level of quality and design for all our components and solutions.

Grâce à la coopération étroite avec nos clients nous sommes en mesure d'intégrer chaque demande spéciale ou exigence particulière du marché directement dans nos processus de développement et de fabrication. L'anticipation de points faibles potentiels, le suivi continu des spécifications de processus et des contrôles fins rigoureux nous permettent d'obtenir un niveau très élevé en matière de qualité et de design pour l'ensemble de nos composants et solutions.

Optimal solutions for all kinds of applications



Motor Homes















Boating

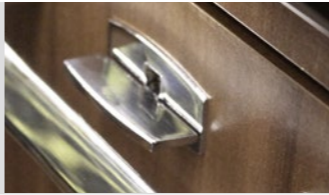

Caravan



Holiday Homes

06		Door Entry Handles	34		Coat Hooks
9		Functional Handles • Snap In	38		Systems for Door Handles
14		Hook Locking System	42		Cable Outlets
16		Functional Knobs • Push In Plus • Snap In	45		Multifunctional Solutions • Lighting • Rail handles • Counter fittings • Glass shelf holders • Multifunctional knob
22		Locking Systems			TFT-Holder
30		Handle Bars • with Function • without Function	52		TFT-Holder



More handle catalogues:
• Metal handles
• Metal handles news

Door entry handles



Please come in.

When entering a new boat, the first handle you are going to touch will be the door handhold. A kind of business card that should give a positive first impression with regard to quality and design.

In collaboration with its customers, confurn develops the perfect solutions for designing this important accessory part, no matter whether a specific size, a special design matching the interior fittings, a discrete or wide-area lighting or different surfaces are required.

So put the design of your « business card » into professional hands to develop the perfect match to your product.



ART.-NO.	⊕ ⊖	↕	↔	📦	🔧	🛒
56168.****	450	51	493	33	M6/11	10

Artificial leather and LED



ART.-NO.	⊕ ⊖	↕	↔	📦	🔧	🛒
56120.****	460	50	491,3	35	M 6/12	10

Artificial leather and LED
Attachment from the front possible (with sleeves)
Exclusive version – on demand



ART.-NO.	⊕ ⊖	↕	↔	📦	🔧	🛒
56269.****	406	53	445	36,8	Ø 5,5	

Artificial leather and LED
Exclusive version – on demand



ART.-NO.	⊕ ⊖	↕	↔	📦	🔧	🛒
56268.****	406	53	445	36,8	Ø 5,5	

LED
Exclusive version – on demand



ART.-NO.							
56222.****	460/410	53,7	475,4	30	M5/12	16	

Attachment from the front possible (with sleeves)
Exclusive version – on demand



ART.-NO.							
56212.****	510/460	53,7	525,4	31,5	M5/12	16	

Attachment from the front possible (with sleeves)
Exclusive version – on demand



ART.-NO.							
56041.****	320	55	340	30	Ø 5,0	16	

Exclusive version – on demand



ART.-NO.							
56104.****	406	47,3	416,2	28	Ø 4,5	30	

Exclusive version – on demand

Functional Handles



Closed system.

Confurn offers a variety of functional handles and functional knobs, matching locking systems as well as functional solutions for latches and coat hooks.

Thanks to the close collaboration with our customers we are able to perfectly harmonize design with innovative technology and sophisticated functionality.

Our studies consider the whole system, not just a single component. This makes it possible for us to create complex solutions for functional handles with matching locking systems that will optimally equip your caravan or boat.





ART.-NO.						
56106.****	224	35	234	22	M4/6	200

Locking system Snap In



ART.-NO.						
56025.****	192	30	210	22	M4/9	40

Bail handle including functional knob
Locking system Snap In



ART.-NO.						
56073.****	160	31	194	17	M4/7	72
56200.****	160	31	194	17	M4/7	72

(1) For straight panels
(2) For curved panels
Locking system Snap In



ART.-NO.						
56225.****	224	27	260	14	M4	20

Exclusive version – on demand



ART.-NO.						
56219.****	160	31	194	17	M4/7	60

Locking system Snap In



ART.-NO.						
56238.****	224	27	264	28,1	M4/7,5	20

Exclusive version – on demand



ART.-NO.						
56220.****	64	2,5	100	17		432

Decorative profile for 56219.0083



ART.-NO.						
56255.****	186	27,6	196	13,5	M4/6	

Functional handle "INTEGRO"
Hook In



ART.-NO.						
56045.****	192	30	210	22	M4/9	

Bail handle including functional knob
Locking system Snap In



ART.-NO.						
56046.****		43,9	22	26,9	M4	175

Knop incl. function
Locking system Snap In
Exclusive version – on demand



ART.-NO.						
56141.****	128	30	210	29,5	M 6 / 9	80

Bail handle including functional knob
Locking system Snap In



ART.-NO.						
56050.****	160	38,6	184	19,3	M 4 / 10	72

Bail handle including internal function
Schlosssystem Snap In



ART.-NO.						
56208.****	96	29	151		M 4	

Bail handle including functional knob
Locking system Snap In



ART.-NO.						
56214.****	160	37	197	18,2	M 4	100

Exclusive version – on demand



ART.-NO.						
56139.****	128	24	158	19	M 4	80

Bail handle including functional knob
Locking system Snap In



ART.-NO.						
56237.****	160	37	188	13,4	M 4 / 13,5	100

Exclusive version – on demand



ART.-NO.						
56142.****	160	25	194	22	M 4 / 6	

Bail handle including functional knob
Locking system Snap In



ART.-NO.						
56103.****	32	23,3	155	32,2	M 4 / 6,5	100

Recessed handle including functional knob
Locking system Snap In



ART.-NO.						
56131.****	128	33,7	144		M 4	80

Bail handle including functional knob
Locking system Snap In



ART.-NO.						
56024.****	32	24	80	32	M 6 / 12	120

Recessed handle including functional knob
Locking system Snap In

Hook Locking System



Good functionality.

Similar to the handles with locking function, the hook locking systems ensure the technical locking of your furniture element.

However, being visually much smaller and slender, their main focus lies on pure functionality. Connected by a strike, it is the optimal and space-saving solution for a safe and discreet locking of your furniture element.

Another possibility is the use of a hook locking system in combination with a family of handles by your choice. If a compatible handle is used, the locking system can be positioned behind the grip slot. Thus, the visual appearance of a family of handles will not be interrupted by a functional handle and the design of the furniture remains uniform.



ART.-NO.						
56351.****	18	23	48	24,8	Ø 3,70	

"Hook In" Handle



ART.-NO.						
56907.****	32	21,1	43	max 58,6	Ø 5,8	200
56267.****	32	21,1	43	63,1	Ø 5,8	200

Exclusive version – on demand



ART.-NO.						
56918.****	32	21,1	43	max 58,6	Ø 5,8	200

Exclusive version – on demand



ART.-NO.						
56911.****	32	21,6	45		M4/6	200

Exclusive version – on demand



ART.-NO.						
56914.****	32	21,1	43	max 58,6	Ø 5,8	500

Plastic

Functional Knobs



Well closed.

Similar to the handles with locking function, the knobs with locking function ensure the technical locking of your furniture element.

However, being visually much smaller and slender, their main focus lies on pure functionality as well as design. An optimal and space-saving solution for a safe and discreet locking of your furniture element.

Another possibility is the use of a knob with locking function in combination with a family of handles by your choice. If a compatible handle is used, the locking system can be positioned behind the grip slot. Thus, the visual appearance of a family of handles will not be interrupted by a functional handle and the design of the furniture remains uniform.



ART.-NO.					
56353.****		35,5	41,5	25,2	

Functional knob "Evolution"
Newly developed knob with locking function for the lock Push In « Evolution » 56356.****



ART.-NO.					
56354.****		35	40,8	25,3	

Functional knob "Evolution"
Newly developed knob with locking function for the lock Push In « Evolution » 56356.****



ART.-NO.					
56355.****		24,6	42	25,3	

Functional knob "Evolution"
Newly developed knob with locking function for the lock Push In « Evolution » 56356.****





ART.-NO.						
56174.****	48	20,5	80	17,5	M 4	200
56175.****		28	37	10,5	M 6/8	200

Push knob with escutcheon
Locking system Push in Plus
Exclusive version – on demand



ART.-NO.						
56126.****	48	37	65	21	M 6/8	160

Square „Push In“, central actuation
Locking system Push in Plus
Exclusive version – on demand



ART.-NO.						
56130.****	32	37	65	21	M 6/8	160

Square „Push In“, side actuation
Locking system Push in Plus
Exclusive version – on demand



ART.-NO.						
56163.****	23,5	35	35	19		120/30

Knob „Push In“ with threaded pin
Locking system Push in Plus



ART.-NO.						
56196.****		38	38	23,7	M 6/8	50

Push knob with escutcheon
Locking system Push in Plus



ART.-NO.						
56207.****		38	38	23,7	M 6/8	50

Push knob with escutcheon
Locking system Push in Plus



ART.-NO.						
56205.****		38	38	23,7	M 6/8	50

Push knob with escutcheon
Locking system Push in Plus



ART.-NO.						
56206.****		38	38	23,7	M 6/8	50

Push knob with escutcheon
Locking system Push in Plus



ART.-NO.						
56258.****		38	38	22,2	M 6/8	50

Push knob with escutcheon
Plastic
Locking system Push in Plus



ART.-NO.						
56227.****	48	28	60	20	M4 / 8	50
56226.****		20	40,5	16,5	M6 / 10	50

For 16 mm panels | Locking system Push in Plus
Exclusive version – on demand



ART.-NO.						
56231.****	48	28	60	16	M4 / 8	50
56226.****		20	40,5	16,5	M6 / 10	50

For 14 mm panels | Locking system Push in Plus
Exclusive version – on demand



ART.-NO.						
56228.****		28	60	21,5	M4 / 8	50
56226.****		20	40,5	16,5	M6 / 10	50

Für gewölbte Platten | Locking system Push in Plus
Exclusive version – on demand



ART.-NO.						
56033.****						

Push knob with escutcheon
Locking system Snap In

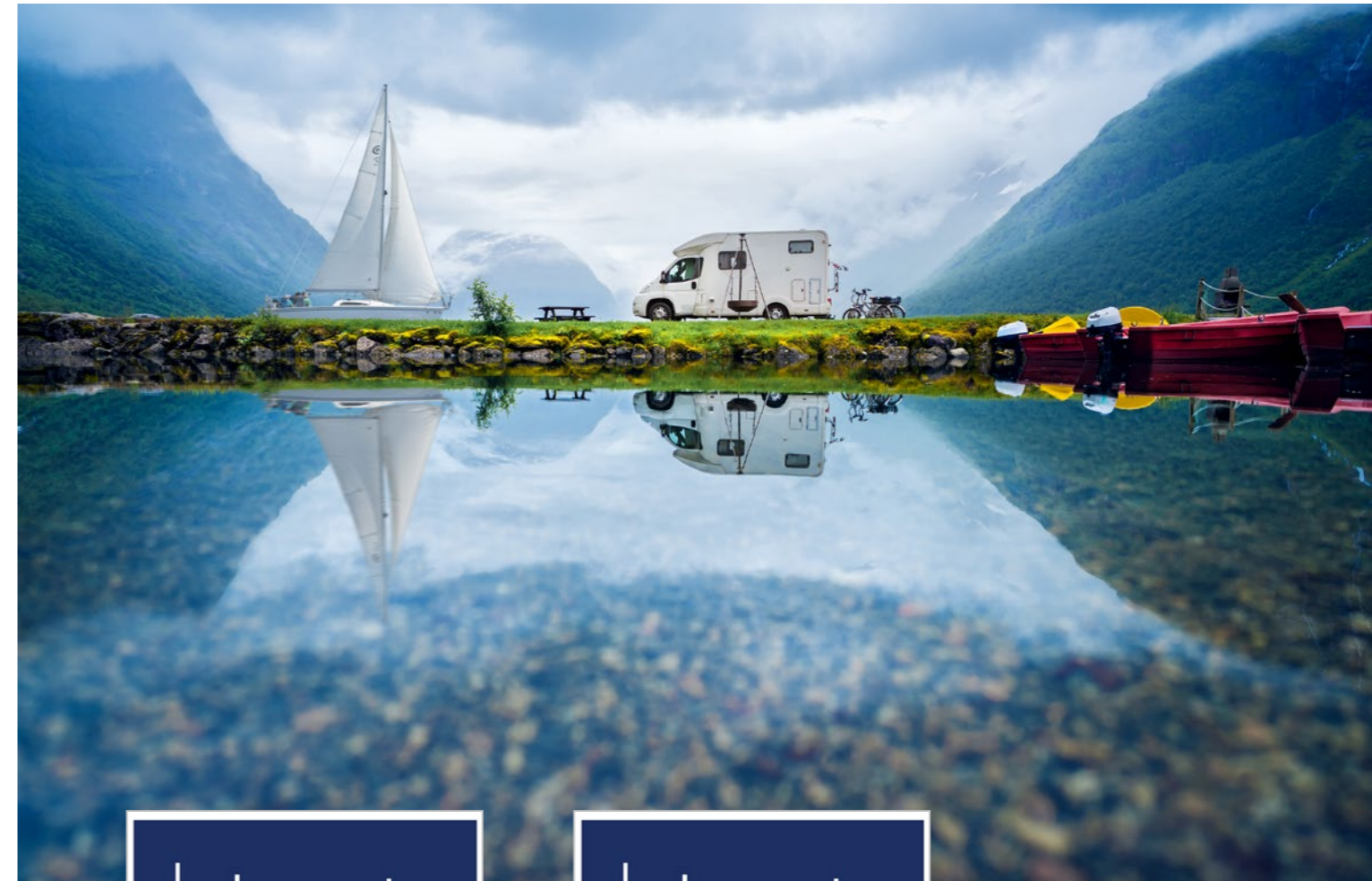

More handle catalogues:

- Metal handles
- Metal handle news

Locking Systems

Strikes

Flap fittings



ART.-NO.

56356.****

Locking system Push In "Evolution"

Newly developed function lock with a very shallow height

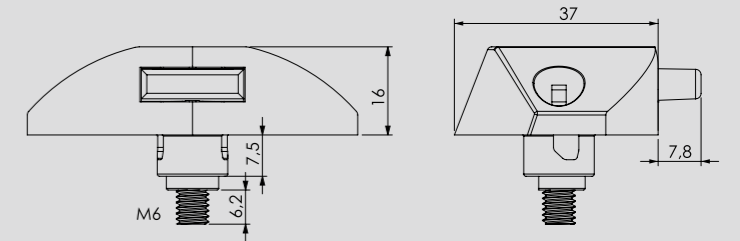

Work in the background.

Well hidden but indispensable: The locking systems do the actual work in all technically lockable furniture elements. A high quality mechanism provides the standard to ensure the longevity of the complete system.

It is in this respect that the focus of our developments lies in the lightness of materials as well as space-saving solutions in the interior of the furniture element.

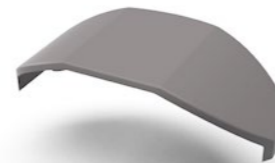

ART.-NO.

56357.****

Cap for 56356.**** Push In "Evolution"

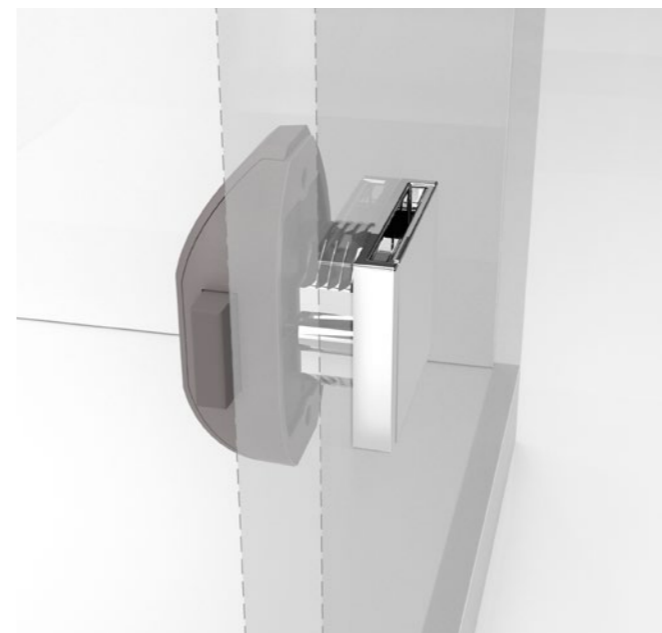



ART.-NO.

56123.0300

Locking system Push In Plus V 1 with M6 threaded pin
Standard version for 16 mm panels
Other panel sizes on demand



ART.-NO.

56107.****

Locking system Snap In with plunger
For handles with inner function



ART.-NO.

56123.0400

Locking system Push In Plus V 2 with M6 threaded pin
Standard version for 16 mm panels
Other panel sizes on demand



ART.-NO.

56215.****

Locking system Snap In with plunger
For handles with inner function
For 22 mm panels



ART.-NO.

56166.****

Assembly frame 1 mm for lock Push In Plus V 1 and V 2
For 15 mm panels



ART.-NO.

56026.****

Locking system Snap In with long plunger



ART.-NO.

56229.****

















Assembly frame 3 mm for lock Push In Plus V 1 and V 2
For 13 mm panels







ART.-NO.

56031.****

Locking system Snap In with long plunger

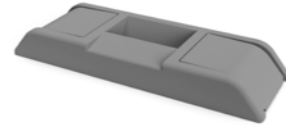
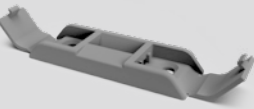
	56120.****		56026.****
	56073.**** 56200.****		56026.****
	56219.****		56026.****
	56025.****		56031.****
	56045.****		56026.****
	56103.****		56026.****
	56024.****		56026.****
	56046.****		56031.****
	56141.****		56026.****
	56208.****		56026.****
	56139.****		56026.****
	56142.****		56026.****
	56131.****		56026.****
	56050.****		56107.**** 56215.****
	56214.****		56107.**** 56215.****
	56237.****		56107.**** 56215.****
	56225.****		56031.****
	56238.****		56031.****

	56174.**** 56175.****		56123.0400
	56126.****		56123.0300
	56130.****		56123.0300
	56163.****		56123.0400
	56196.****		56123.0300
	56207.****		56123.0300
	56205.****		56123.0300
	56206.****		56123.0300
	56258.****		56123.0300
	56227.**** 56226.****		56123.0300
	56231.**** 56226.****		56123.0300
	56228.**** 56226.****		56123.0300
	56033.****		56026.****
	56353.****		56356.****
	56354.****		56356.****
	56355.****		56356.****

	<p>ART.-NO.</p> <p>56352.****</p> <p>Strike with cover flaps for the screw connections</p>	
	<p>ART.-NO.</p> <p>56080.****</p> <p>Strike</p>	
	<p>ART.-NO.</p> <p>56089.****</p> <p>Strike with damper and double spring plunger for curved panels</p>	
	<p>ART.-NO.</p> <p>56099.****</p> <p>Strike with damper and double spring plunger for straight panels</p>	
	<p>ART.-NO.</p> <p>56199.****</p> <p>Strike Grey, RAL 7005 Exclusive version – on demand</p>	



ART.-NO.

54230.****

Strike



ART.-NO.

54000.0501

Strike above



ART.-NO.

54000.0601

Strike below



ART.-NO.

54002.0000

Strike above



ART.-NO.

54908.****

Strike
ABS, light grey uni
Exclusive version – on demand



ART.-NO.

56115.****

Flap fitting, closed, 3 pieces



ART.-NO.

56904.****

Flap fitting – Pin connection / Cover



ART.-NO.

56117.****

Pin plate for straight doors



ART.-NO.

56144.****

Pin plate for curved doors

Handle Bars

With & and without locking function



Meeting all situations.

Handle strips are ideal for underlining the design of your furniture element. Regardless whether it is a drawer, a door or a flap door, there will be no disturbing elements on the front surface. The handle strips easily adapt to each kind of furniture.

We offer a variety of designs, in different surfaces, variable lengths, with or without locking function.

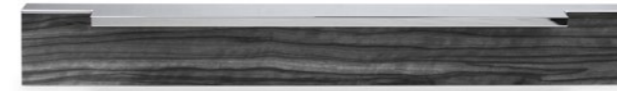

ART.-NO.						
53008.****		10	variabel	37		50 / 100

Exclusive version – on demand



ART.-NO.						
53003.****		17	variabel	40		40

Exclusive version – on demand

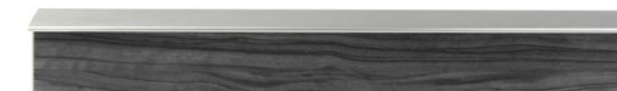

ART.-NO.						
53004.****		20,1	variabel	43		

Exclusive version – on demand



ART.-NO.						
53002.****		25,4	variabel	27,14		50

Exclusive version – on demand

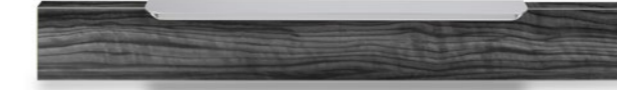

ART.-NO.						
53007.****		17,4	380	40		100

Exclusive version – on demand

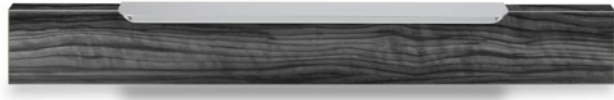

ART.-NO.						
54000.0101		11,8	380	40,5		40
54000.0102		11,8	433	40,5		40

Handle bar with locking function
Exclusive version – on demand

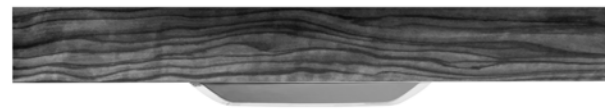

ART.-NO.					
54001.****		24	194	18,5	60

Handle bar with locking function
Exclusive version – on demand

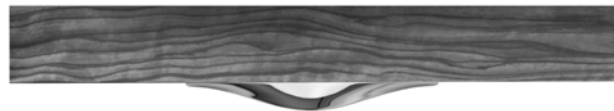

ART.-NO.					
54003.****		25	200	22,1	60

Handle bar with locking function
Exclusive version – on demand

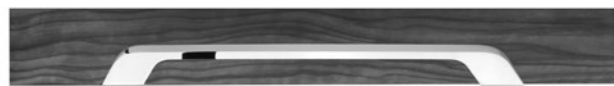

ART.-NO.					
54004.****			312	47,8	40

Handle bar with locking function
Exclusive version – on demand



Handle bars with locking function



Coat hooks



Aiming high.

Space-saving solutions are highly demanded, especially by the caravan and boat industry. Our coat hooks offer an elegant solution for storing your everyday clothes, towels or other hanging items.

Whether a discreet slim design is required or a practical flip hook – you will find in our range of products a solution matching perfectly your needs.



ART.-NO.	⊕ ⊖	▭	▭	▭	▭	🛒
56359.****	10	65,4	20	29	Ø 4,2	

Coat hook, two pieces
With additional folding hook, inside



ART.-NO.	⊕ ⊖	▭	▭	▭	▭	🛒
56350.****	12	58	24,5		Ø 4,2	

Coat hook, two pieces



ART.-NO.	⊕ ⊖	▭	▭	▭	▭	🛒
56192.****	22	68,3	40,5	17,1	Ø 4,6	60 / 15

Coat hook, two pieces
Zamac



ART.-NO.	⊕ ⊖	▭	▭	▭	▭	🛒
56252.****	18	65	21	14	Ø 4,6	

Coat hook, two pieces



ART.-NO.	⊕ ⊖	▭	▭	▭	▭	🛒
56253.****	27	70	33,5	13,5		

Coat hook, two pieces



ART.-NO.						
56260.****	50	140	16	13,6		

Coat hook, two pieces
Version to be mounted into a milled recess



ART.-NO.
56261.****

Silicon ring for coat hook 56260
Version to be mounted on a furniture front
Different colours available



ART.-NO.						
56042.****		45,8	18	23		300

Coat hook, two pieces
Hook Zamak, Insert made of ABS plastic
Exclusive version – on demand



ART.-NO.						
56081.****	11,9	51	17	31,5	Ø 4	350

Coat hook, two pieces
Hook Zamak, Insert made of ABS plastic



ART.-NO.						
56035.****	16	65	32	32	Ø 4,2	180

Coat hook, two pieces
Hook Zamak, Insert made of ABS plastic



ART.-NO.						
56147.****		54,6	30,2	31	Ø 4	400

Coat hook, two pieces
Plastic, ABS



ART.-NO.						
82024.****	23	65	20,5	36	Ø 4,7	160 / 320

Coat hook
Plastic, ABS



ART.-NO.						
56084.****		40	8	17,7		140

Coat hook
Zamak



ART.-NO.						
50404.****		53	16,8	25		200

Coat hook
Zamak

Systems for Door Handles & Rotary Knobs



Ready to hand.

The moment your customer puts his hand on a door handle, it will give him an idea of the quality and the workmanship of the complete interior. That is why the design, the handle's haptic and its quality impression should make a perfect business card for your company.

On request, we will be gladly prepared to develop your individual solution meeting perfectly your object and requirements.



ART.-NO.

56047.****

Door handle set with 2 roses and two rose inserts
Exclusive version – on demand

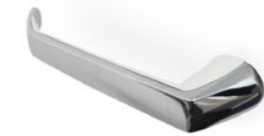

ART.-NO.

56083.****

Door handle, two pieces



ART.-NO.

56034.****

Door handle Set
Each handle is also available in 2 different surface variations.
Here: chrome front, matt chrome back



ART.-NO.

56043.****

Door handle
56044.****: Corresponding door handle with square pin



ART.-NO.

56137.****

Rotary knobs with lock 26,3 mm



ART.-NO.

56072.****

Door handle system with lock



ART.-NO.

56058.****

Door handle

56057.****: Corresponding door handle with square pin



ART.-NO.

56275.****

Rotary knob with square pin
Exclusive version – on demand



ART.-NO.

56178.****

Rotary knob with square pin
Exclusive version – on demand



ART.-NO.

56162.****

Rotary knob with square pin
Exclusive version – on demand

Systems for door handles



Cable Outlets & Electrification









Tidy and powerful.

Cable tangle? Nobody wants it! A flat battery? Nobody wants it either! Even on the move, we want to have the possibility to connect, recharge and use our electronic devices in an easy and convenient way.

We offer a variety of solutions for optimal cable management as well as easy-to-handle electrification systems. Of course, all designed according to your individual needs. Do not hesitate to contact us for more information on this subject.



	<p>ART.-NO. 20011.****</p> <p>Plastic cable outlet Ø 80 mm</p>
	<p>ART.-NO. 20006.****</p> <p>Plastic cable outlet Ø 60 mm</p>
	<p>ART.-NO. 20084.****</p> <p>Metal cable outlet with brush Ø 80 mm</p>
	<p>ART.-NO. 82017.****</p> <p>Metal cable outlet with brush Ø 60 mm</p>
	<p>ART.-NO. 82565.****</p> <p>Point - Cable outlet with connections for various modules such as socket including 2 m extension cable, USB and RJ45 (LAN)</p> 



ART.-NO.

82774.****

Cable outlet with induction - square | Ø 80 mm



ART.-NO.

82773.****

Cable outlet with induction - round | Ø 80 mm



ART.-NO.

82813.****

Inductive charger | Ø 58,1 mm
Under the worktop



ART.-NO.

82786.****

Active USB cable outlet | Ø 60/80 mm



ART.-NO.

82785.****

Tablet Holder

Multifunctional Solutions



Open for every wish you have.

New ideas, wishes or even problems often occur during the development or working process. Then, it is a matter of finding the optimal solution to achieve a perfect result! It is often the small details that can transform "a good idea" into "a perfect solution". Especially in the area of boating and caravanning, these solutions are more popular than ever, because only the companies that stand out of the crowd are able to offer their customers solutions meeting exactly their requirements.

It is confurn that finds, develops and offers exactly these solutions in collaboration with your company. We are open for every wish you have!



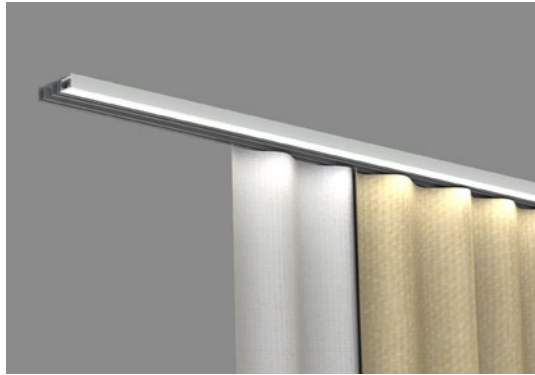

ART.-NO.		
82902.****	Leiste Rail Rail	
82903.****	Diffusorprofil Diffusor profile	
82904.****	Blende Panel Panneau cache 14 mm	
82905.****	Blende Panel Panneau cache 35 mm	



ART.-NO.						
56235.****	54,2	35,7	83,7	35,4	Ø 4 mm	

Exclusive version - on demand

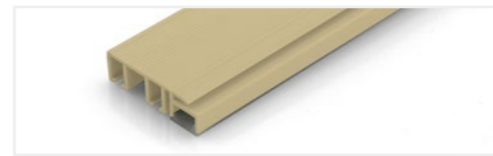

Curtain rail system – illuminable

The integrable LED technology provides this innovative system with an effective long-life lighting and illuminates the room with indirect lighting. Due to the 2-rail system, the attachment of a lower and an upper curtain is easily possible. The plain-colored panels are available in 2 heights and can be finished with a decor according to customer wishes.

Length: 3,00 m (cut ware)
 Material: Plastic

Delivery without lighting



ART.-NO.						
56223.****	26	177,3	30	27,8	Ø 3,3	

Exclusive version - on demand





ART.-NO.	Beschreibung	ART.-NO.	Beschreibung
82671.****	Base left	82906.****	Base left
82672.****	Base right	82907.****	Base right
82673.****	Base middle	82908.****	Base middle
82674.****	Base corner	82909.****	Base corner
82675.****	Alu profile	82675.****	Alu profile

Rail handle system consisting of an aluminum profile and different bases made of zamac

Exclusive version – on demand



ART.-NO.

56216.****

Plastic corner connector
Exclusive version – on demand



ART.-NO.

56217.****

Plastic corner connector
Exclusive version – on demand



ART.-NO.	Länge [mm]
82680.****	802
82681.****	696
82682.****	304

Rail handle system consisting of profile 20 x 3 mm, Brushed stainless steel

Various bending radii can be realized on request.



ART.-NO.

40010.****

Shelf-support, including fixing kit



ART.-NO.	Beschreibung
82825.****	Base
82824.****	Profile



Rail handle system consisting of an aluminum profile and base made of zamac



ART.-NO.						
56122.****	60	15	85	6,5	Ø 3,2	200

Support for mirrors or glass panels

Exclusive version – on demand



ART.-NO.
56909.****

Multifunctional knob, 2 pieces
Zamac, plastic
Ring chrome polished, Softtouch insert

Exclusive version – on demand



ART.-NO.						
56181.****		20	20	2		1000

Mirror and glass door application, self-adhesive



ART.-NO.	ART.-NO.	ART.-NO.
56256.****	56248.****	56249.****

Manoeuvring handle

Exclusive version – on demand

End pieces of manoeuvring handle with length adjustable tube

Exclusive version – on demand



ART.-NO.

Support for glass panels, different versions

On demand



More durable

Flat screen holder with release lever



ART.-NO.
82690.****
Two arms
82690.0000 Total length of swivel arm 670 mm

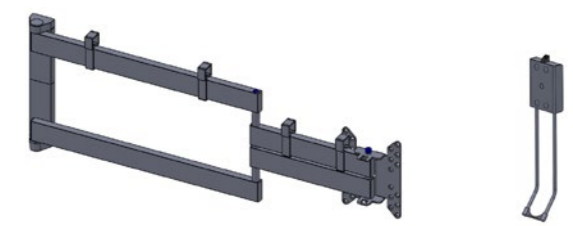

Kit including :
TV holder Flat L
and release lever



ART.-NO.
82690.01.0000
One arm
82690.01.0000 Total length of swivel arm 240 mm

Dimensions::

Width : 455 mm / 230 mm
 Depth : 39 mm
 High : 251 mm
 Material : Aluminium/Zamac/PA
 Surface : Aluminium eanodized/black

Product features::

- Very flat and space-saving depth (39mm)
- Wall mount with « snap-on mechanism » to lock the screen
- Easy snap-in and unlocking system through release lever
- Release lever optionally mounted upwards or downwards
- Length of release lever can be adjusted on request
- Tension controlled swivel arm
- Optimal cable guidance through cable clips
- Modern, timeless design







20006.****	43	56103.****	13	56212.****	8	56275.****	40
20011.****	43	56104.****	8	56214.****	13	56279.****	20
20084.****	43	56106.****	10	56215.****	25	56280.****	20
40010.****	49	56107.****	25	56216.****	49	56281.****	19
53002.****	31	56112.****	37	56217.****	49	56282.****	19
53003.****	31	56115.****	29	56219.****	10	56287.****	18
53004.****	31	56117.****	29	56220.****	10	56288.****	18
53007.****	31	56120.****	7	56222.****	8	56289.****	18
53008.****	31	56122.****	50	56223.****	47	56290.****	18
54000.0101	32	56123.0300	24	56225.****	11	56291.****	21
54000.0102	32	56123.0400	24	56226.****	20	56292.****	19
54000.0501	28	56126.****	18	56227.****	20	56294.****	21
54000.0601	28	56130.****	18	56228.****	20	56316.****	19
54001.****	32	56131.****	12	56229.****	24	56317.****	20
54002.0000	28	56137.****	39	56230.****	28	56318.****	20
54003.****	32	56139.****	12	56231.****	20	56321.****	21
54004.****	32	56141.****	12	56235.****	47	56322.****	21
56026.****	25	56142.****	12	56236.****	17	56323.****	21
56031.****	25	56144.****	29	56237.****	13	56350.****	35
56032.****	37	56146.****	22	56238.****	11	56351.****	15
56033.****	20	56147.****	37	56240.****	25	56352.****	27
56034.****	39	56156.****	36	56244.****	17	56353.****	17
56035.****	37	56160.****	36	56245.****	17	56354.****	17
56041.****	8	56162.****	40	56246.****	17	56355.****	17
56042.****	36	56163.****	18	56247.****	17	56356.****	23
56043.****	39	56166.****	24	56248.****	51	56357.****	23
56045.****	10	56168.****	7	56249.****	51	56359.****	35
56046.****	11	56171.****	23	56250.****	17	56904.****	29
56047.****	39	56174.****	18	56251.****	17	56907.****	15
56058.****	40	56175.****	18	56252.****	35	56908.****	28
56061.****	25	56178.****	40	56253.****	35	56909.****	51
56072.****	40	56192.****	35	56255.****	11	56911.****	15
56080.****	27	56196.****	19	56256.****	51	56914.****	15
56081.****	36	56199.****	27	56260.****	36	56918.****	15
56083.****	39	56205.****	19	56261.****	36	82017.****	43
56084.****	37	56206.****	19	56267.****	15	82024.****	37
56089.****	27	56207.****	19	56268.****	7	82565.****	43
56099.****	27	56208.****	19	56269.****	7	82671.****	48

82672.****	48	82904.****	46
82673.****	48	82905.****	46
82674.****	48	82906.****	48
82675.****	48	82907.****	48
82680.****	48	82908.****	48
82681.****	48	82909.****	48
82682.****	48		
82690.****	53		
82690.01.0000	53		
82773.****	44		
82774.****	44		
82785.****	44		
82786.****	44		
82813.****	44		
82824.****	48		
82825.****	48		
82902.****	46		
82903.****	46		

OBERFLÄCHEN | SURFACES | FINITIONS

ART.-NO.	FARBE	COLOUR	FINITION
****.0071	Chrom glänzend	Chrome plated	Chromé brillant
****.0073	Chrom matt	Pearl chrome	Chromé mat
****.0074	Edelstahleffekt	Satin nickel	Effet inox
****.0083	Chrom matt lack.	Pearl chrome painted	Chromé mat laqué
****.0079	Schwarz matt lack.	Black matt painted	Noir mat

ZEICHEN | SIGNS | SCHÉMA

	Lochabstand Hole distance Entr'axe		Höhe Height Hauteur		Breite Width Largeur		Tiefe Depth Profondeur
	Durchmesser Diameter Diamètre		Gewindetiefe Depth of thread Profondeur de filetage		Verpackungseinheit Packing unit Unité d'emballage		

confurn | Sundernkämpe 14 | D-32549 Bad Oeynhausen
Fon +49(0)5734 / 9609-0 | Fax +49(0)5734 / 9609-80 /-81 /-82
www.confurn.de | info@confurn.de

