

| elements

 **CADRO**
| Frame system



 CADRO | Frame system



Unlimited creativity.

CADRO | Frame system

Base	6 – 19
Lighting	20 – 23
Glass display case	24 – 29
Room concept	30 – 35
Processing and technology	36 – 37
Overview	38 – 47



Unlimited creativity.

A frame system that unconditionally adapts to your creative ideas – does that exist? Our furniture frame system CADRO consists of different kinds of profiles and connectors, seamlessly adapting itself to existing furniture elements or captivates as a stand-alone object.

Due to special frame profiles developed for different panel types and sophisticated fixing possibilities, this system stands out from the crowd: different connectors, different frame profiles, an “invisible” and adjustable wall mounting device, connection possibilities in every direction as well as options to integrate side panels and/or sliding doors or flap doors.

Whatever you choose, the system remains simple and easy to handle.



CADRO | Base



The structure of the basic components.

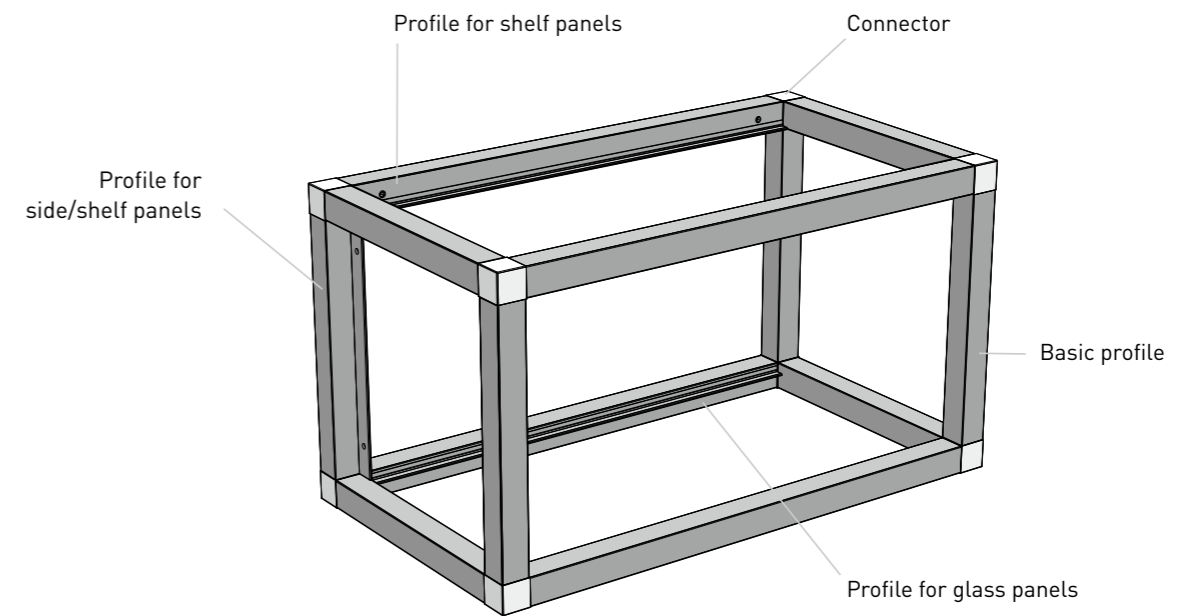

The heart of the system consists of connectors and profiles that can be used according to your own creative ideas. Whether long or short, wide or narrow, open or closed, on the wall or on the floor, almost every piece of furniture is possible.

Our profiles and connectors are perfectly coordinated in colour. Our CADRO basic components are available in the three standard colours black matt, silver matt and stainless steel matt brushed.

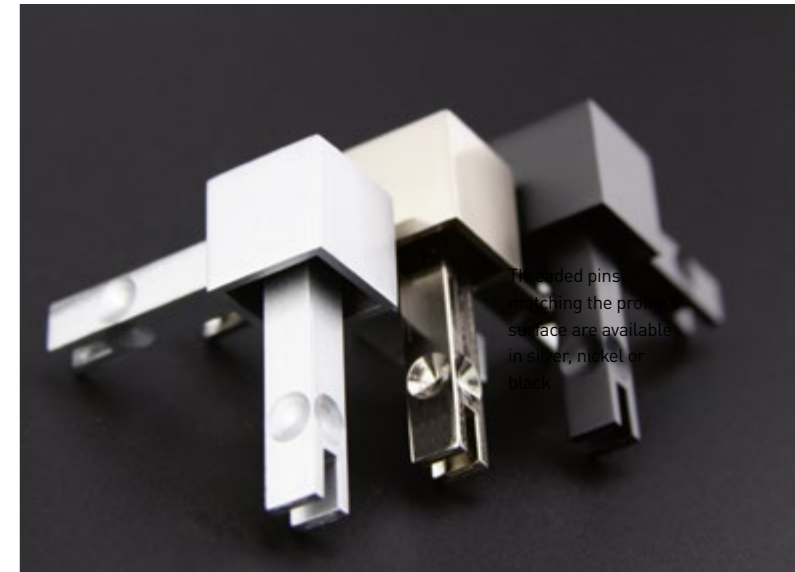
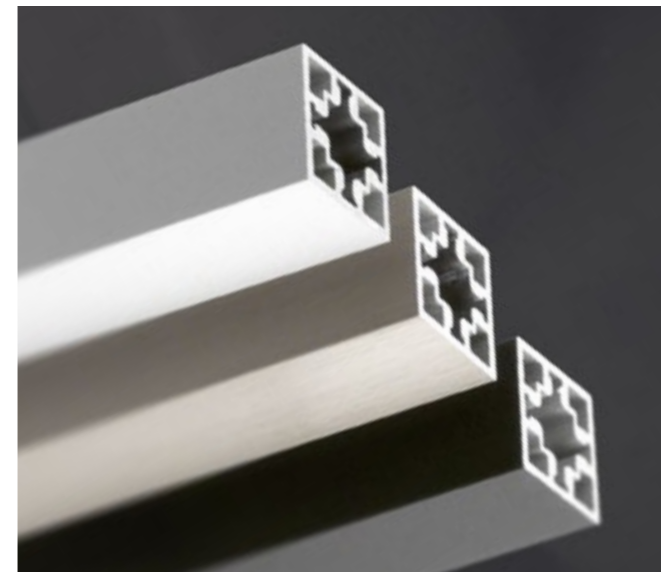

Included pins matching the profile surface are available in silver, nickel or black.

The basic profiles.

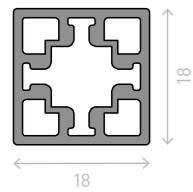

Basic profile
82792.****

The cross section measure 18 x 18 mm forms the basis of all CADRO system profiles. Thus, all profiles including their functions and assembly possibilities have been specially developed for the use of 16 mm thick wall and shelf panels.

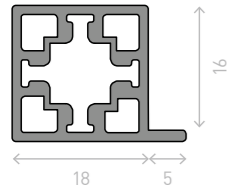

Profile for shelf panels
82793.****

For the positioning of 16 mm shelf panels



Shelf panel
16 mm

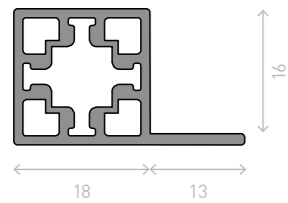

Profile for side/shelf panels
82912.****

For the screwing of 16 mm shelf panels.



3,5 x 12 mm
countersunk
head screw

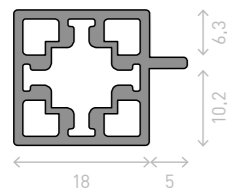

Profile for glass panels
6 mm
82794.****



Glass panel 6 mm

Can also be used for the assembly of wooden panels with peripheral groove.
(See also page 12)



The basic connectors.



Double
82925.****

Triple-2D
82932.****

Triple-3D
82795.****

Quadruple
82796.****

Quintuple
82797.****

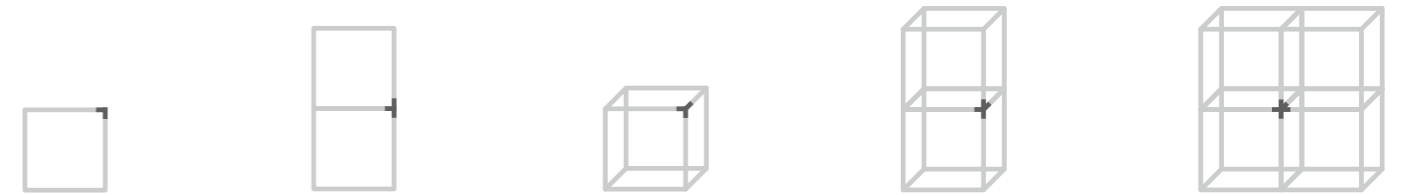

The safe connection.

To ensure a high stability, strength and safety, the profiles are connected by using threaded pins which are screwed into the connectors. The pins are optionally supplied with a thread securing glue and fastened with a 0,8 – 1 Nm torque. The M5 grub screws are fixed in the surrounding conical cavities in the connector's arms pulling together the connector and the profile without leaving any gap. Due to the predetermined distance of the threaded hole, the connection gains its outstanding stability and security. This technology allows every user to creatively use the system with generous tolerances.

For more details regarding the thread hole see page 36.

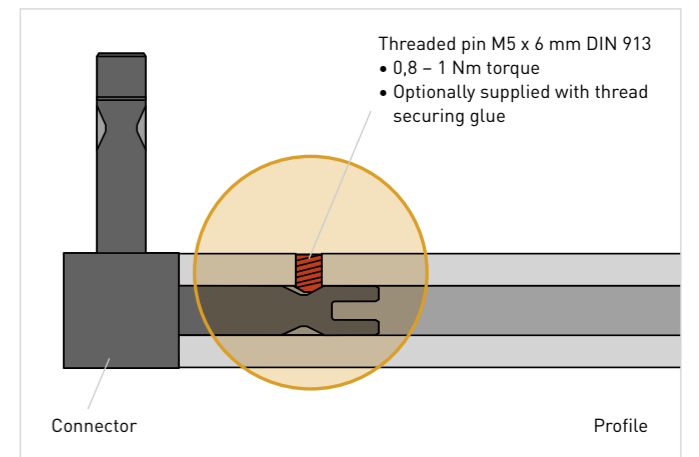

Threaded pin M5 x 6 mm DIN 913
• 0,8 – 1 Nm torque
• Optionally supplied with thread securing glue

Connector

Profile

Threaded pins matching the profile's surface are available in silver, nickel or black



Threaded pin
82918.****



The invisible wall mounting system.

Our idea: an elegant system needs an elegant and discrete fixing solution. The result is simple but unbeatable in its function:

A supporting system that is fastened to the wall on which the furniture element can be hung, fixed and adjusted afterwards. The system allows an easy and precise adjustment of height even after mounting. The result: the wall mounting system is not visible from the front side and the furniture element is safely and firmly fixed.



The wall mounting system is supplied as a complete kit consisting of supporting system, threaded pin in 3 colours and flat head screw with spacer for the fine adjustment.

For more details regarding the cutout and the thread hole see page 36.

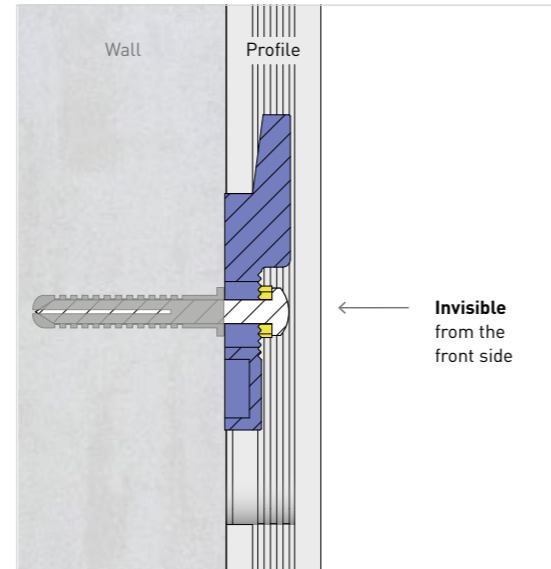
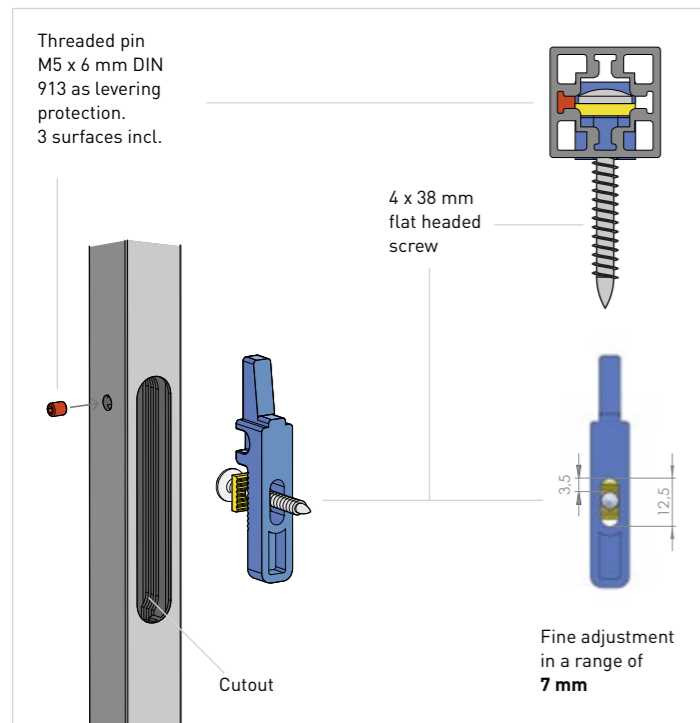

alternative:

It is also possible to fix the system with a flat head screw that afterwards can be covered with a cap.

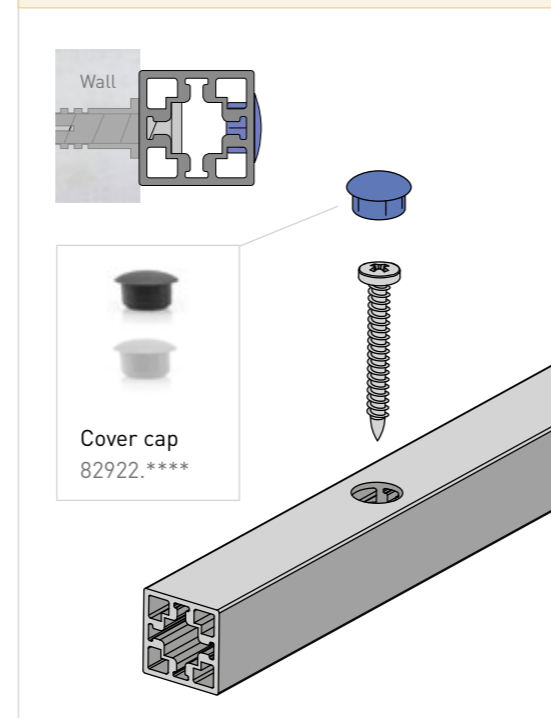

The perfect connection.

In order to offer a discreet and stable solution to integrate the system into existing furniture elements, we have developed a fastening insert that is as simple as it is efficient.

The connection using the fastening sleeve is screwed into the existing furniture element either at the top or at the bottom. Then simply place the predrilled CADRO profile in the required position and secure it with a threaded pin... and all is done!

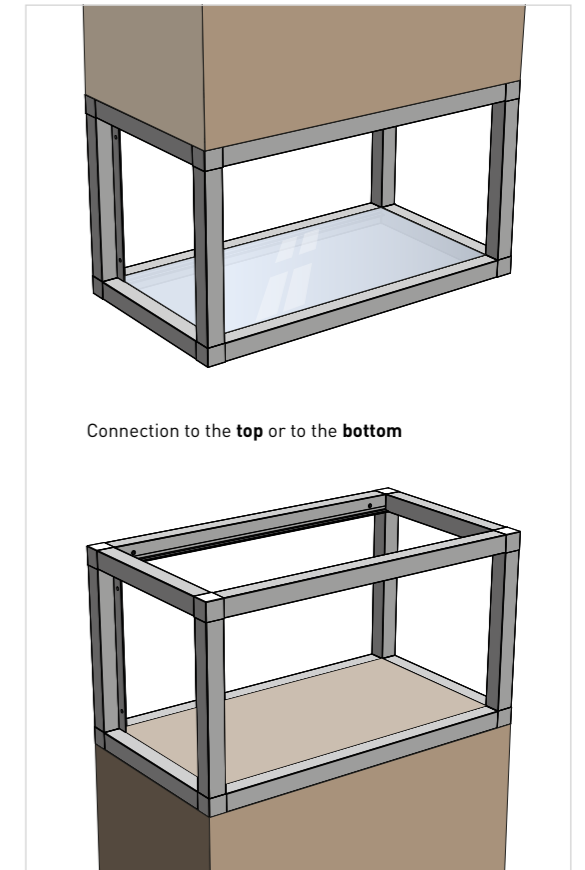
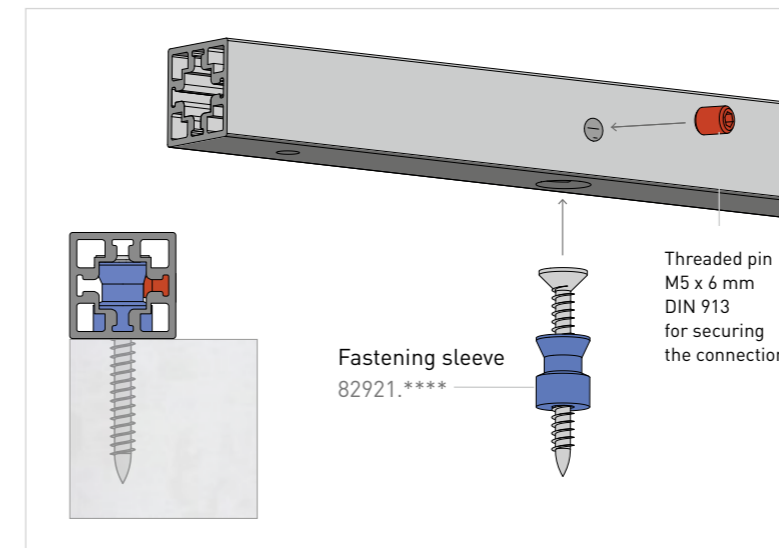

Side panels and back panels.

In order to create closed furniture elements, side and back panels are required. Our shelf panel profiles are ideal for side cladding. The wall elements are provided with a peripheral groove and thus can be neatly and securely be assembled into the frame without any visible fixation. Or the walls are simply being screwed from the inside or the backside with the profile 82912.**** or 83168.****.

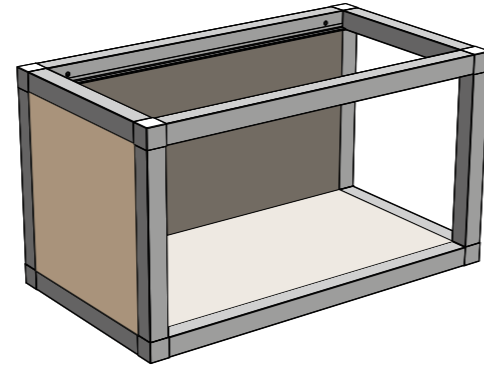

Profiles for side and shelf panels.

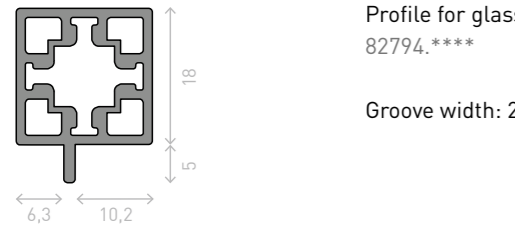

Profile for glass panels
82794.****

Groove width: 2 mm

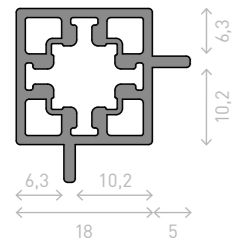

Profile for side/shelf panels
82975.****

Groove width: 2 mm

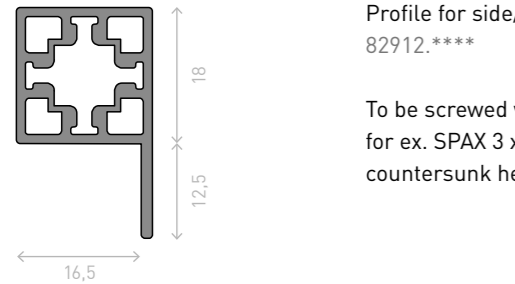

Profile for side/shelf panels
82912.****

To be screwed with
for ex. SPAX 3 x 12 mm
countersunk head screws

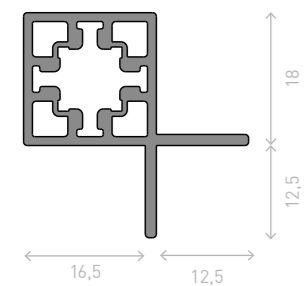

Profile for side/shelf panels
83168.****

To be screwed with
for ex. SPAX 3 x 12 mm
countersunk head screws



Eccentric system.

Eccentric systems offer another possibility to assemble chipboards. Again, this fastening solution is only visible from one side so as not to disturb the aesthetics of the furniture element. All commercially available eccentric systems can be used for this.

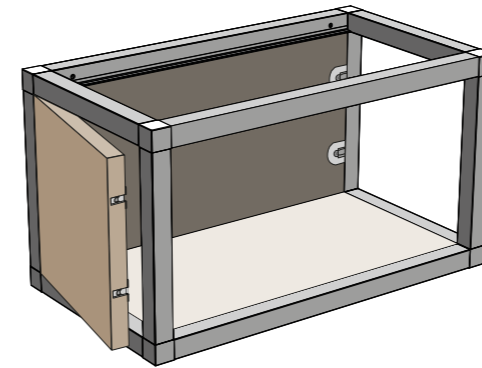

Ball spring plungers.

A very elegant solution is the use of ball spring plungers to fix the side or rear panels. Simply pre-drill the required holes in the edges of the panels and insert the ball spring plungers. For the CADRO profile, you can use the holes of the threaded pins you have already made for the connecting notes.

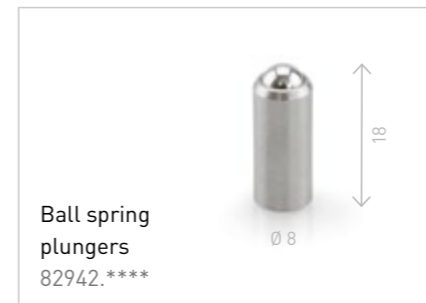

Thanks to an integrated metal spring under the ball, the side or rear panels simply can be „clicked in“. Thus, the fixing system remains invisible from the outside as well as from the inside.

Attention: Not suitable for load-bearing walls or panels.



Open the door.

Another possibility to create your individual piece of furniture is offered by the use of Hettich hinge systems, for example. Besides the attachment of doors inside the frame, it is also possible to fix offset doors. Thus, it is also possible to create completely closed pieces of furniture.

Hinge recommendation.

Hettich Sensys hinges for **inset doors** (base B-4) in combination with Sensys cross mounting plates. The choice of the mounting plate depends on the individual application, e.g. joint 1 mm / cup distance C=4 mm: Sensys 110° hinge for inset doors + cross mounting plate distance 3 mm.

Hettich Sensys hinges for **offset doors** (base 12,5 mm) in combination with Sensys screwable cross mounting plates (being fixed with countersunk head screws, diam. 5,4 x 18 mm). The choice of the mounting plate depends on the individual application, e.g. overlay 17 mm / joint 1 mm / cup distance C=4,5 mm: Sensys 110° hinge for offset doors + cross mounting plate distance 0 mm.

In some cases it may be necessary to support the mounting plates.

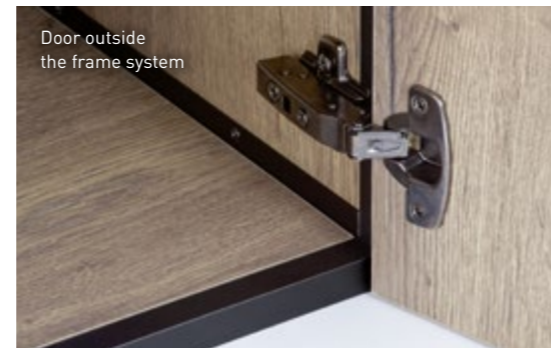

Designed for CADRO.

Handle "STRAIGHT".

Die-cast aluminium

ART.NO.	⊕ ⊖
83154.****	128

Railing handle.

Zamac and aluminium

ART.NO.	⊕ ⊖
56294.****	128
56321.****	160
56322.****	192
56323.****	320

(Special lengths on request.)

- Black super matt painted
- Stainless steel matt brushed



Slide.

Profiles for sliding door in front of the frame system.

Practical and design-oriented. Sliding door variant that runs externally in front of the frame system. The profiles are designed for the **Hettich SlideLine M** or the **SlideLine 66** fitting kits and offer the possibility to insert shelf panels **1** or to additionally screw them **2**. Further hardware manufacturers on request.

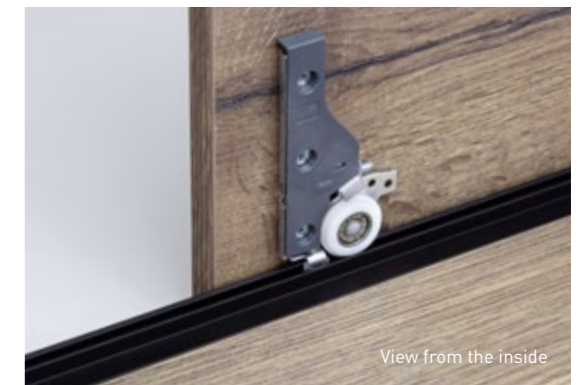
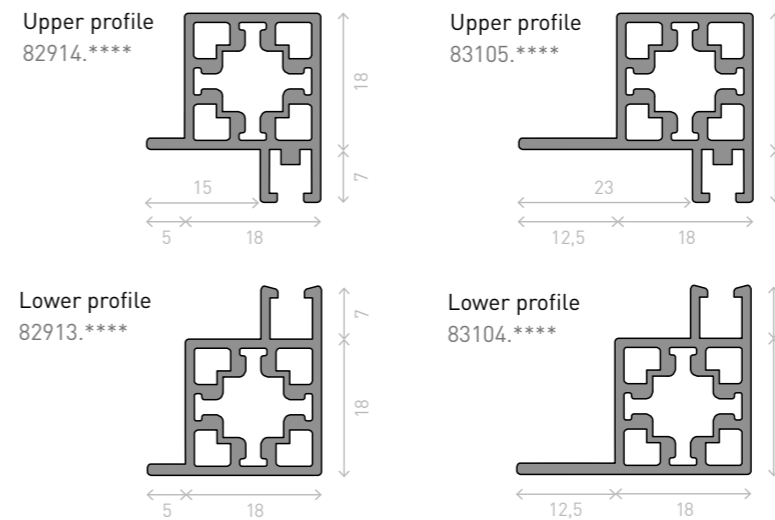

Profiles for sliding door inside the frame system.

Flush-mounted with a clear line. Sliding door variant that runs inside the frame system. The profiles are designed for the **Hettich SlideLine M** or the **SlideLine 66** fitting kits and offer the possibility to insert shelf panels **1** or to additionally screw them **2**. Further hardware manufacturers on request.

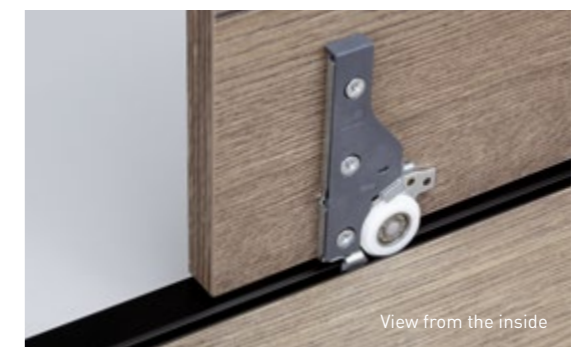
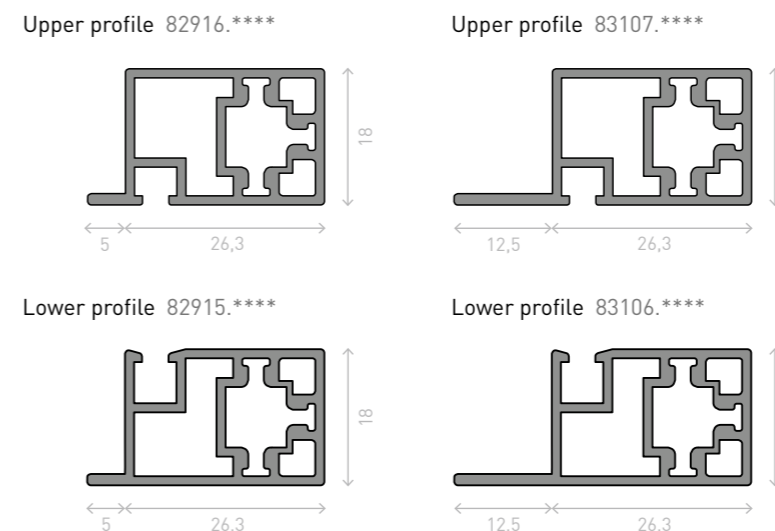

Drawers.

Pull-out drawers made by Hettich.

Quality, design and functionality are inseparably linked with our CADRO frame system. In order to also integrate large-volume drawer elements, we have developed a side profile exclusively for Hettich on which drawers and pull-outs from the AvanTech You range of products can easily be mounted. A small groove in the profile ensures a precise assembly, afterwards the mechanism of the Actro You guiding rail can be completely covered when clipping on the matching cover profiles. Thus, even open shelf constructions including drawer elements can be created in a visually appealing way.

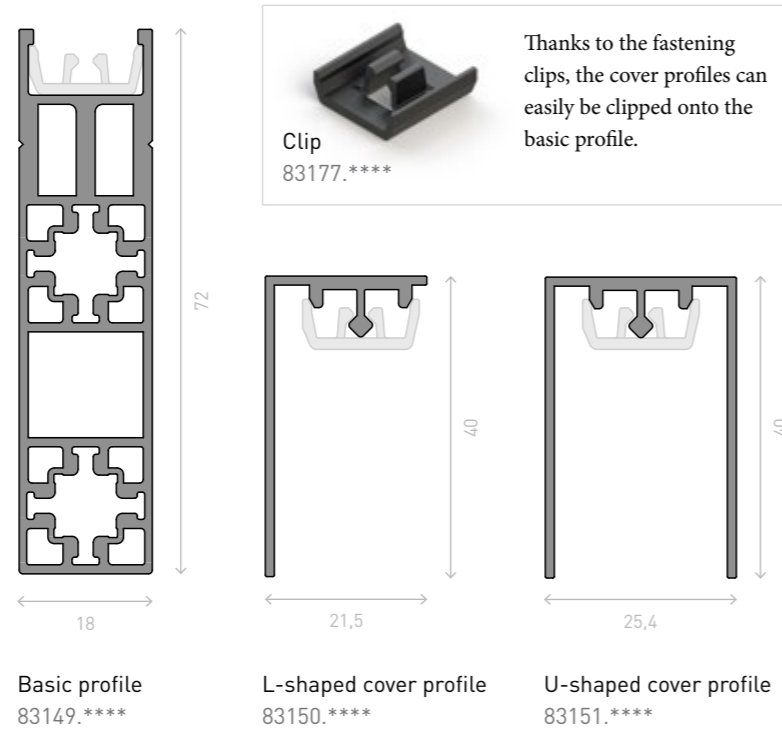
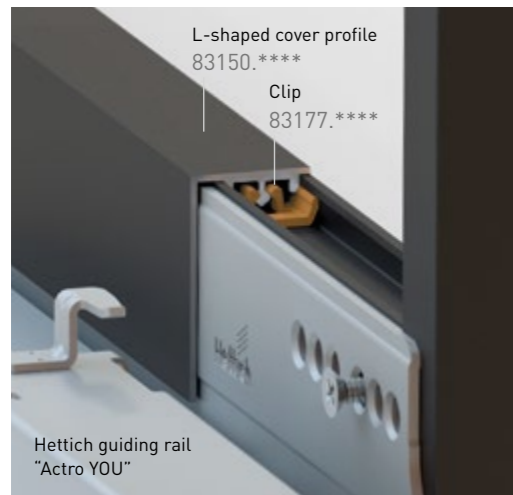
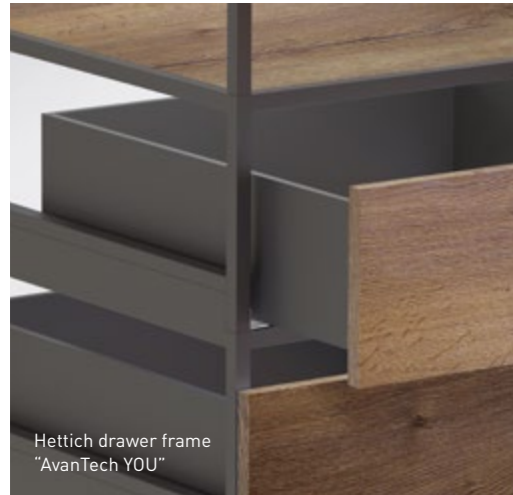

Alternative profile attachment.

The universal connector.

Another possibility to connect the profiles without connectors is the use of the universal connector. It can be screwed through 2 holes on each flat side of the profile and therefore can be used for universal applications. Combined with the flat end cap 82934.*** it is now possible to create closed corner connections, or you use it to connect a crossbar to reinforce your piece of furniture.

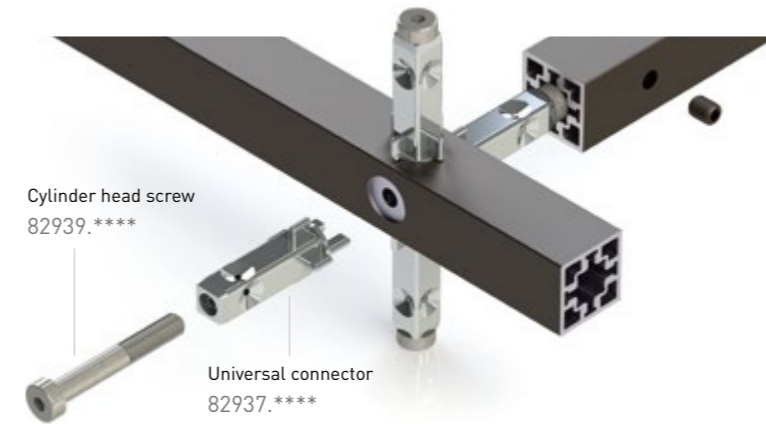

The corner connector.

By using the corner connector, the CADRO profiles can be assembled at right angles without nodes. The profile ends are mitre-cut, the corner connector is inserted and then firmly fixed with the threaded pins. Thus, it is very easy to create mirrors or various kinds of frames.

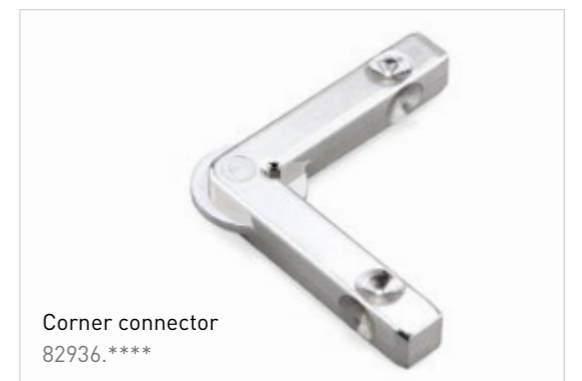
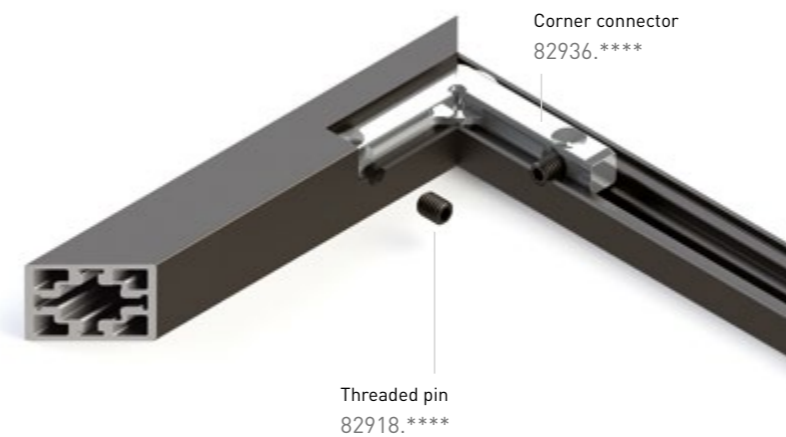

Accessories.

Cover caps for the basic profile.

The cap 82923.**** is used to cover an open basic profile and most suitable for building a piece of furniture that is exposed to heavy loads, e.g. when building a table leg or similar. The cap 82934.**** is used to simply cover an open profile and has a smaller thickness.

Both caps are simply pushed into the profile's end to obtain a safe and neat finish.

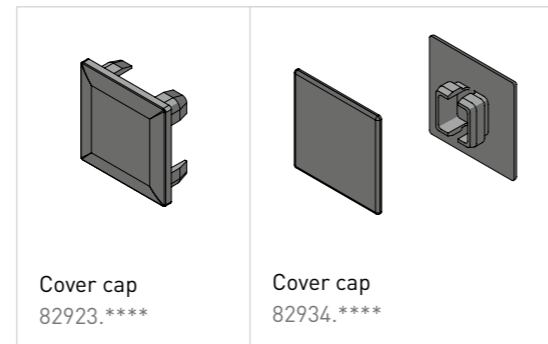

Cover cap for M5 threaded pin.

This specially developed, very discreet cap serves to cover screwed-in threaded pins and gives your piece of furniture an even more uniform look.

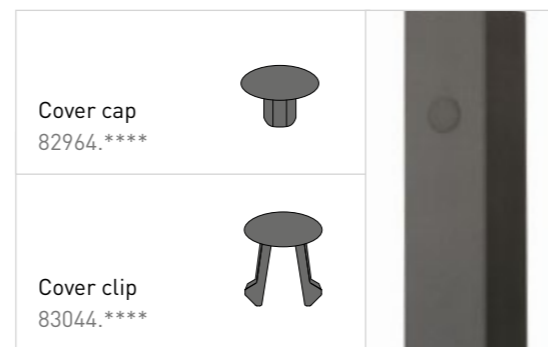

Cover clip for 4–6 mm drilling holes.

The cover cap 83004.**** serves to cover 4-6 mm drilling holes and gives your piece of furniture an even more uniform look.

Castors.

As for furniture elements that have to be mobile (e.g. tea trolleys, TV stands, etc.), the use of castors is an option. There are many versions available on the market, such as versions with or without brake, which are compatible with our CADRO system. The castors should be provided with an M8 or M10 thread. As for M8 threads, a rivet nut has to be used. M10 threads can directly be cut into the profile.



Adjustable foot and connecting thread.

A flexible height adjustment of the furniture leg is very important in furniture design. Our version offers an adjustable range of height from 0 to 20 mm. The foot is simply screwed into the profile's end with the help of our connecting thread 82938.****. This offers an optimal and quick solution to create height-adjustable furniture feet: saw the profile to the required length, insert the connecting thread and screw in the furniture foot, finished!

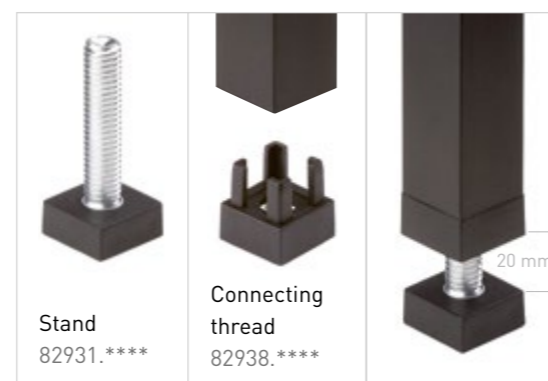

Self-adhesive felt pads.

If your piece of furniture touches the floor with its side profiles and connecting nodes, we recommend the use of our custom-fit felt pads to protect your furniture and your floor from being scratched.



Connectors with height-adjustable stand.



Double with stand 83058.****

Triple-2D with stand 83119.****

Triple-3D with stand 82948.****

Quadruple with stand 82949.****



As for pieces of furniture in touch with the floor with their connectors and profile elements, a height-adjustable foot is indispensable. For exactly this kind of furniture we have developed additional connectors with adjustable stand.

These connectors offer a height-adjustable range from 0–5 mm.



CADRO | Lighting

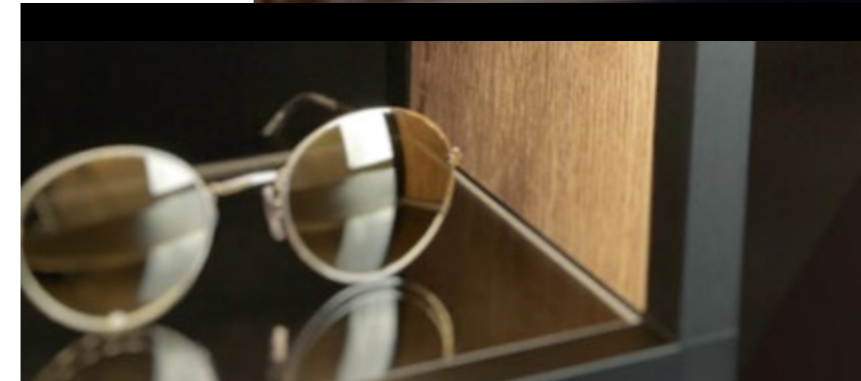

Lights on! Lighting profiles.

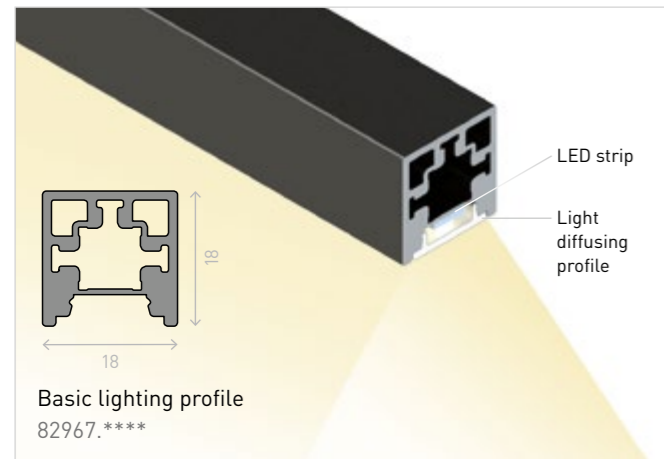

Basic lighting profile.

In the living room, kitchen area or for shop fitting purposes: our specially designed lighting profiles put everything in the right light!

The basic lighting profile can be used for all applications where no shelf panels or back panels are required. In open shelf systems it can be mounted at a top, bottom, front, rear or vertical position in order to create completely new lighting accents.

However, when using the light diffusing profile 82969.0000, you can also insert a glass or plexiglass panel being completely illuminated by the LEDs (see figure below).

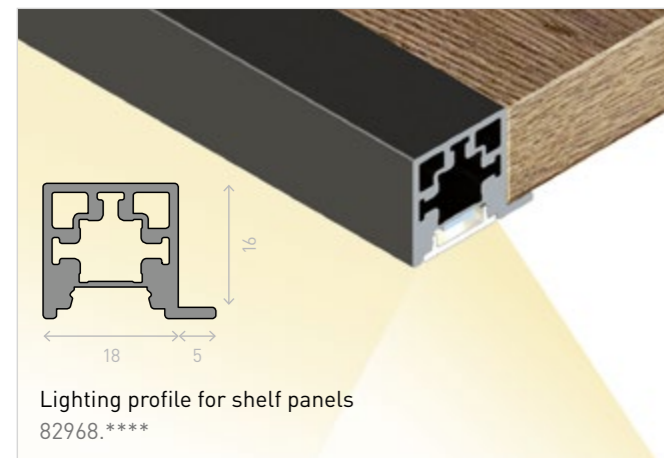

Lighting profile for shelf panels.

The lighting profile for shelf panels is equipped with an additional small bar to fix 16 mm shelf or back panels. Similar to the basic lighting profile, all light diffusing profiles can be used. The interior structure remains the same.

Thanks to the two lighting profiles it is possible to create a large variety of lighting ideas and accents.

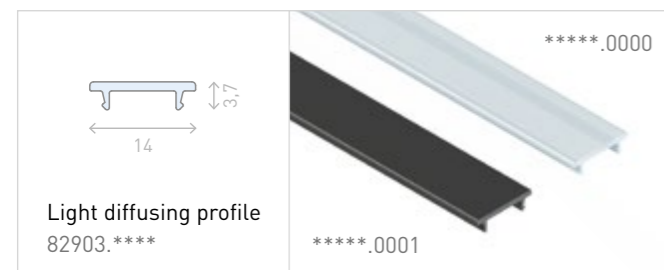

Light diffusing profiles.

Both of our light diffusing profiles after being cut to the required length can simply be clicked on the lighting profile to diffuse the hard light spots of the inserted LED strip.

The light diffusing profile 82903.**** is also available in a matt black version and can be used to cover the cables of the LED power supply.

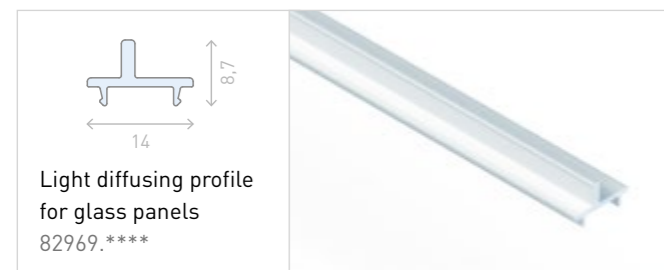

The light diffusing profile 82969.**** has an additional small bar to fix glass or plexiglass panels which then can be completely illuminated.

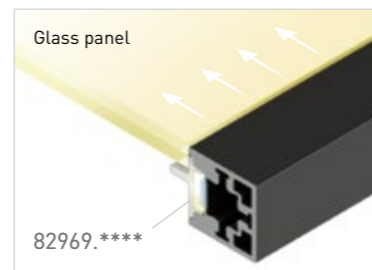

Connectors to guide the lighting cables.

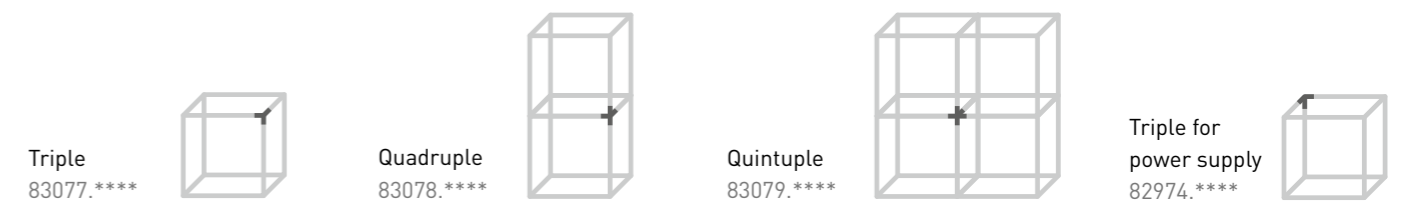

These specially designed connectors are used for a simple and practical guidance of the LED power cables. The connectors have a recess in which the power cables can be placed easily.

The connector 82947.**** is used to guide the power cables towards the back panel or simply to the outside.

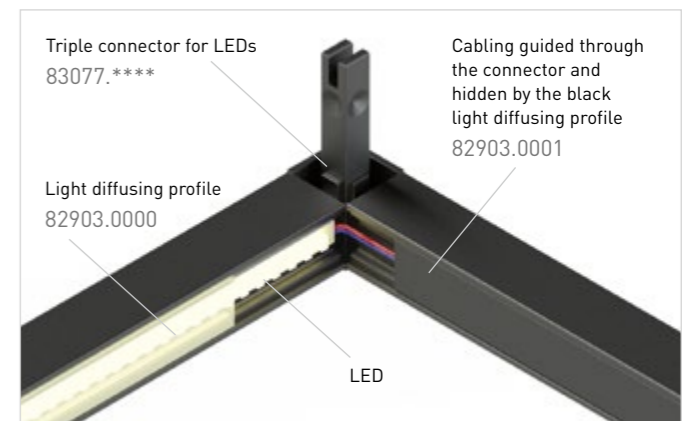
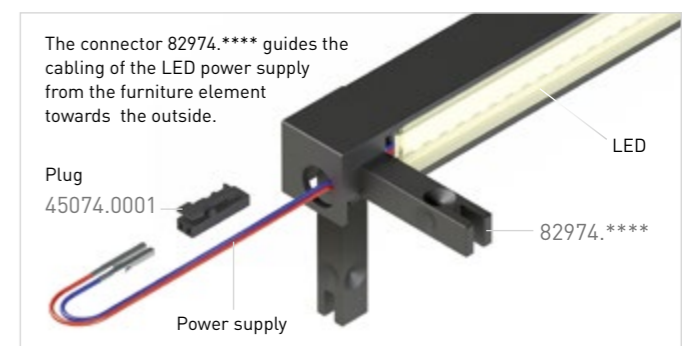

 CADRO | Glass display case



Profiles for glass display cases and glass panels.

Angle profile for glass panels.

One profile – three possibilities. The solid aluminium corner profile 83067.**** forms the basis for a modular construction. In combination with the three plastic clip-on profiles, the following assembly possibilities are provided:

1. Complemented by the clip-on profile 83070.****, two 4 mm glass panels can be mounted in a 90° angle and be fixed in the profile frame.

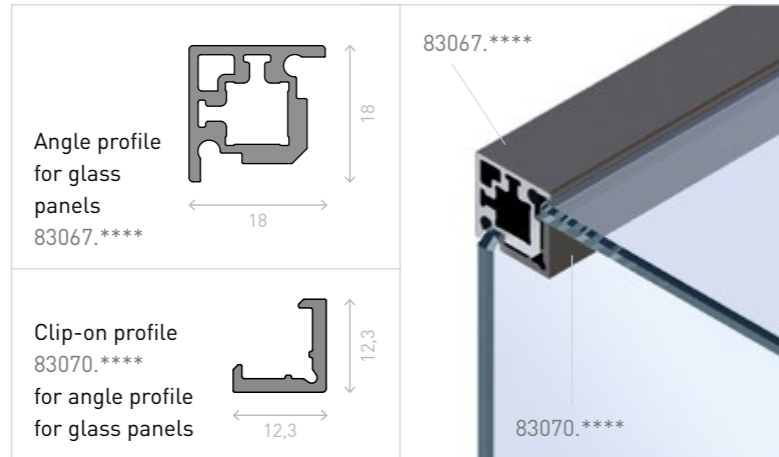

2. The clip-on profile 83071.**** completely covers one side of the basic profile. Thus, only one 4 mm glass panel can be fixed vertically or horizontally.

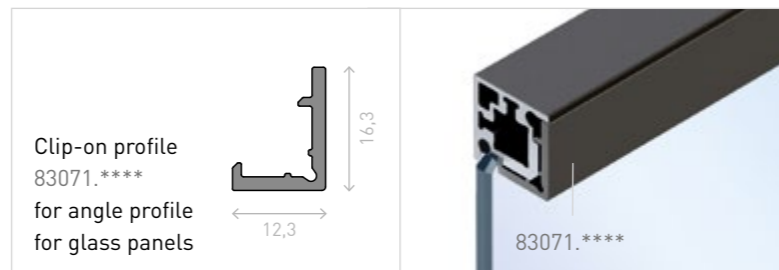

3. The clip-on profile 83072.**** also only serves to firmly fix one 4 mm glass panel. However, it offers the possibility to place a 6 mm glass shelf panel.

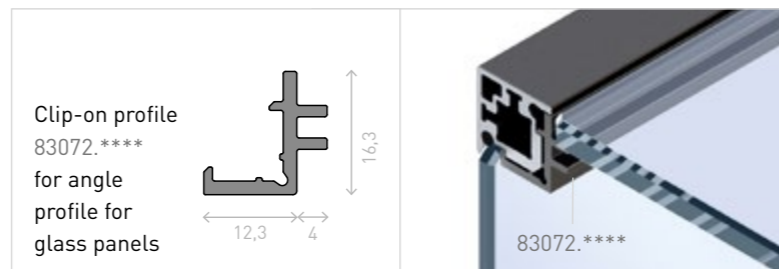

Double profile for glass panels.

This glass panel profile includes the basic profile 83068.**** and the plastic clip-on profile 83073.****. It allows to connect two 4 mm glass panels in one plane, vertically or horizontally.

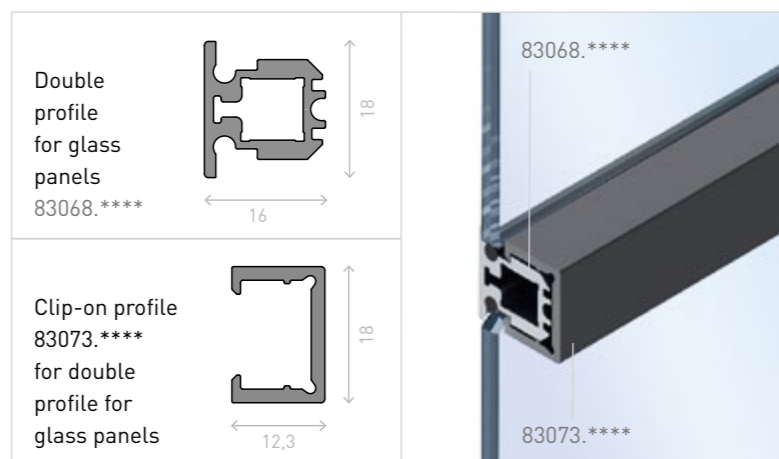

The connectors for glass panel profiles.

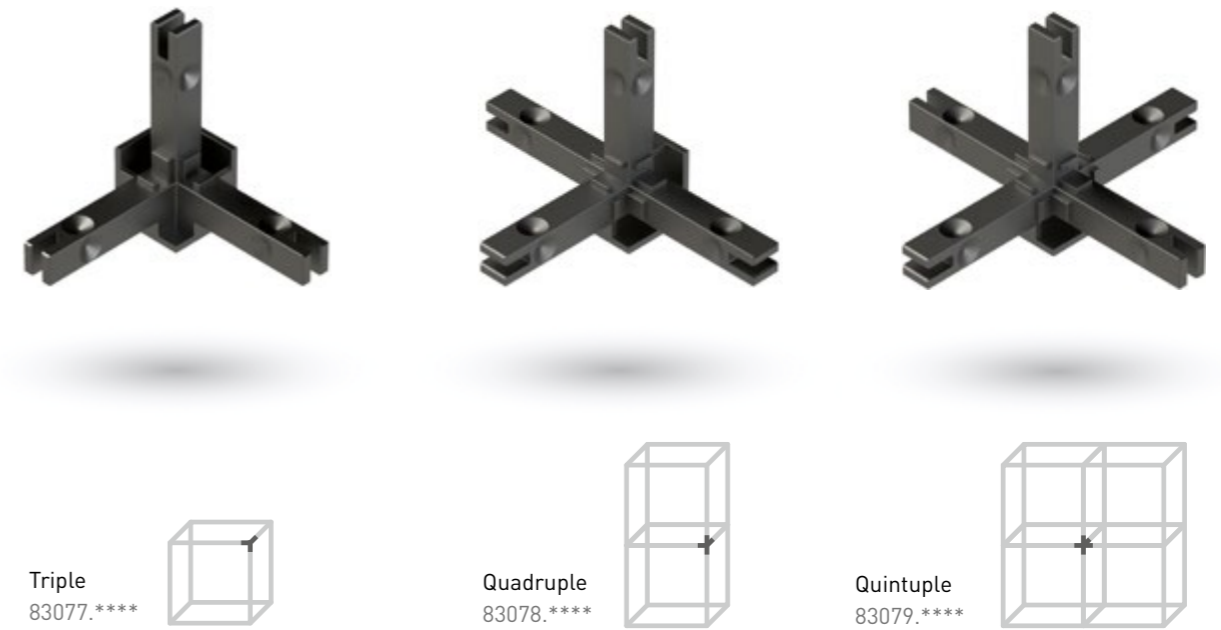

Triple secure fixation.

Through the inclusion of black silicone piping profiles, the glass surfaces are protected against bumps and vibrations. In addition to this, the glass surfaces are bonded to the frame profile by applying sealing tape strips having a width of only 2 mm. With the final assembly of the appropriate clip-on profiles, the glass elements are securely fixed in the CADRO frame system. This creates an absolutely stable cabinet construction.

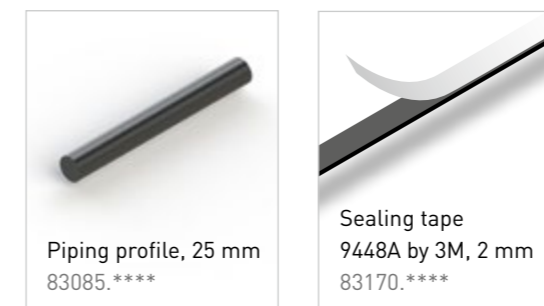

The glass cabinet.

With CADRO Glass display case you are able to build high-quality and functional showcases. All components are coordinated in terms of function and design and perfectly match the CADRO system.

1 Handle attachment.

The handle attachment can easily be positioned at any height on the glass door. A hole in the glass is not required. The handle/knob is attached with an M4 screw before the assembly. Thus, any handle/knob can be chosen – depending on the design.

Glass door-Handle attachment 83142.****

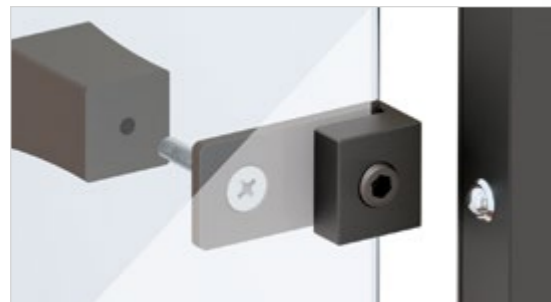

Example-Knobs from our range of products:

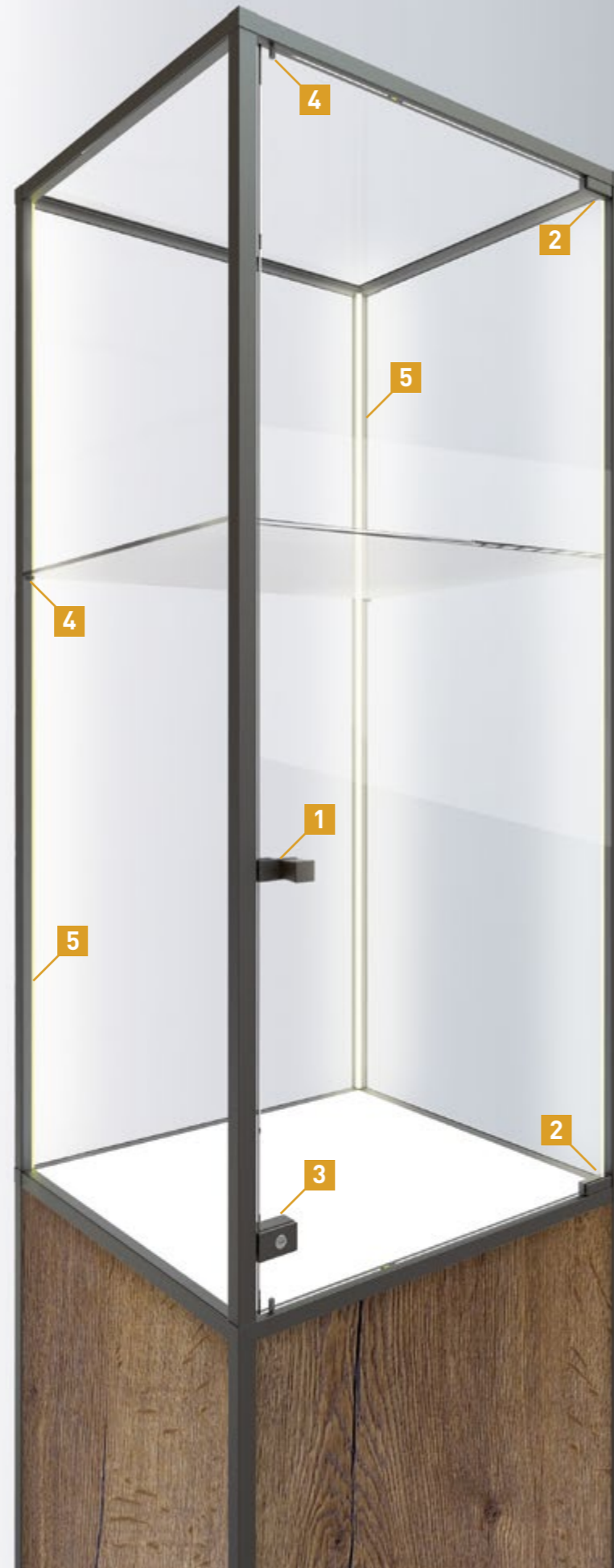

2 Hinges.

The discreetly designed hinges are able to securely hold 4 mm glass panels. They are firmly fixed from the behind with two M8 threaded pins with plastic studs.

Glass door-Hinge 83139.****



3 Lock.

The compact lock matches perfectly our range of CADRO Glass display case elements. The locking pin is held in the profile by a sleeve. An optional ball spring plunger helps to keep the door in the closed position.

Glass door-Lock 83141.****



4 Door stop/Shelf-support.

The door stop kit includes an M4 x 16 mm screw that is screwed into the fixing hole normally being used in the profile. Afterwards, the screw is covered with the matching plastic sleeve. Due to the eccentric drilling in the sleeve, the door hinge can be adjusted.

Glass door-Door stop 83143.****



5 Lighting profiles.

By using the lighting clip-on profiles, corner profiles can be transformed into lighting strips that illuminate exhibits in a particularly discreet and effective way. LED light ribbons (see page 40) are simply glued into the angle profile for glass panels and then disappear neatly behind the lighting clip-on profiles. Due to the foil-coated profiles, light is only emitted at the inner edge of the glass cabinet corner profiles and thus illuminates the interior of the showcase. The profile 83161.**** is used to obtain a closed profile side, e.g. on door panels.

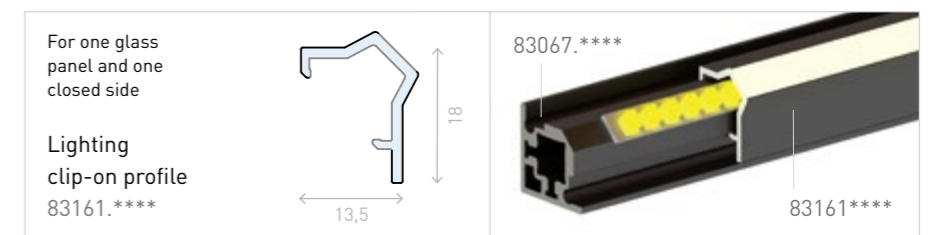
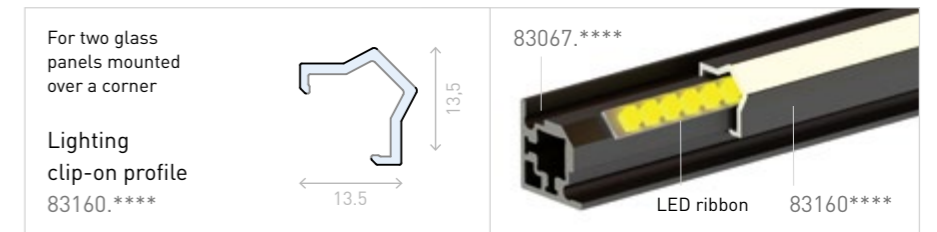

CADRO | Room concept



The connectors.

Ideal for realizing room concepts such as office and shop fittings or fair booth constructions. The connectors of the CADRO Room concept range of products allow the design to leave the limits of 90° angles and to design variable angled profile connections.

Objects can easily be adapted to room conditions and achieve their stability through diagonal struts or wall and floor mounting – especially in the case of large objects without side walls.

The variable connectors up to 180°.

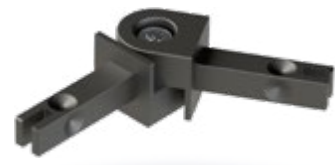

Corner connector up to 180°
83115.****

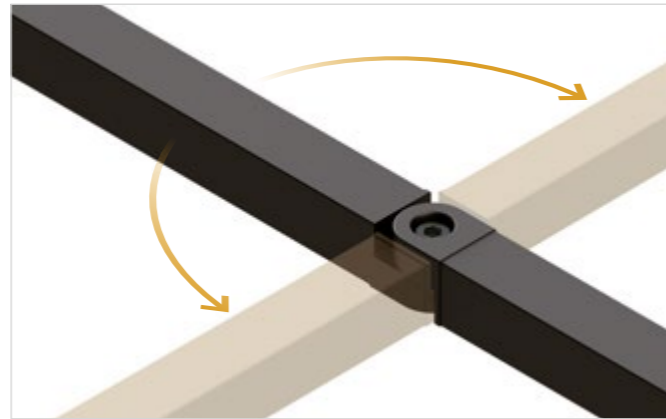

Hinge connector up to 180°
83116.****

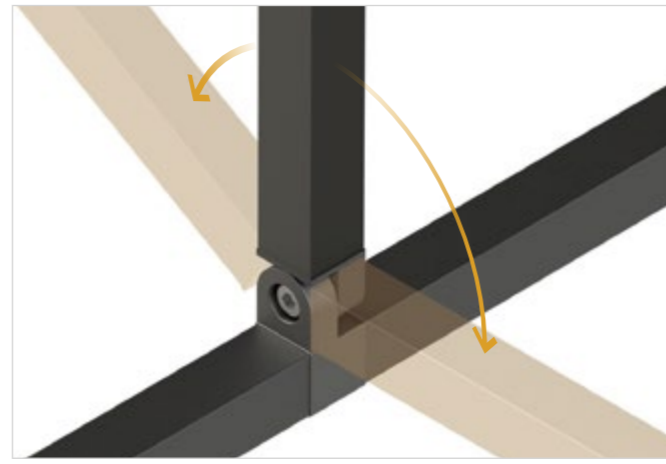

Screwable connector up to 180°
83117.****

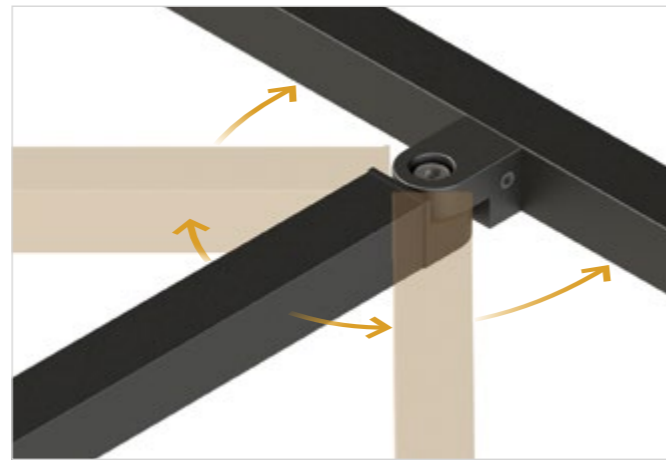

The variable connectors up to 360°.



Hinge connector up to 360°
83118.****

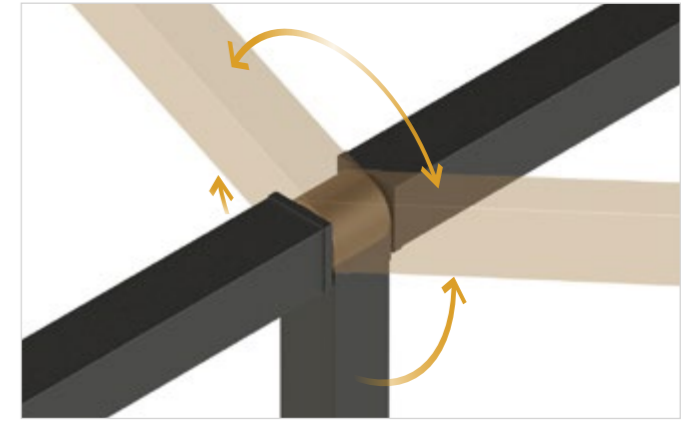
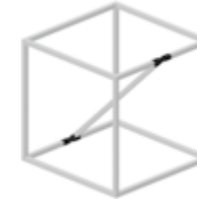

Connector up to 360°
83148.****

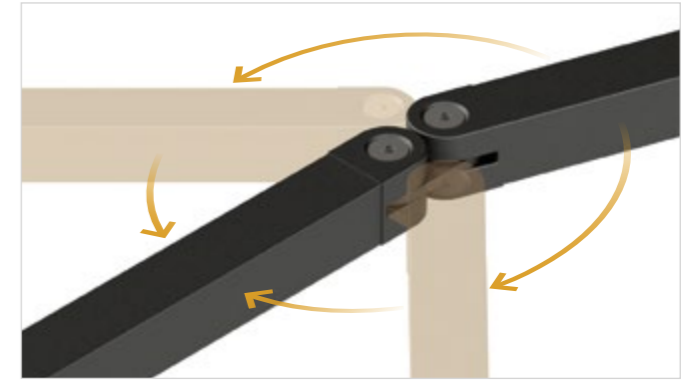

Cross hinge
83103.****



Universal connector 83092.****
and connecting arm 83093.****

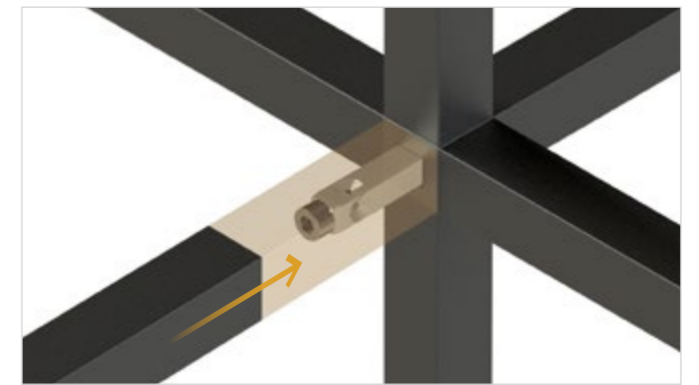

The connecting elements.

The connecting elements specially developed for the CADRO range of products stand for an easy and secure fixation of objects within the room, on walls, floors and ceilings. At the same time they perfectly match the CADRO design.

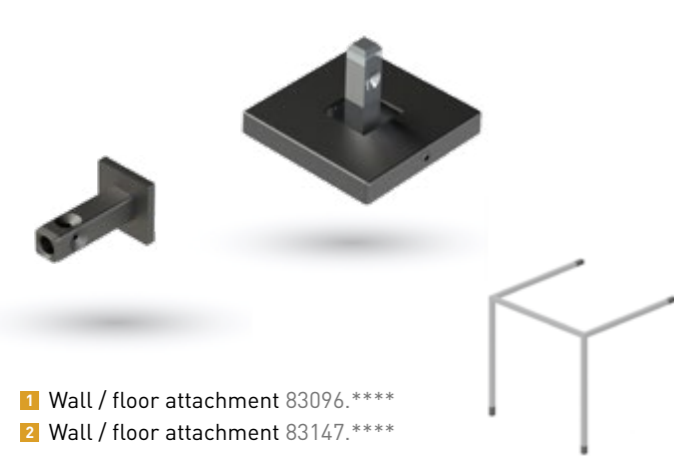

1 Wall / floor attachment 83096.****
2 Wall / floor attachment 83147.****

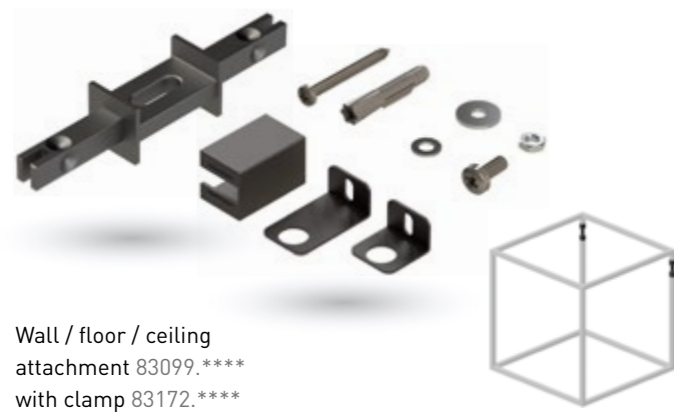
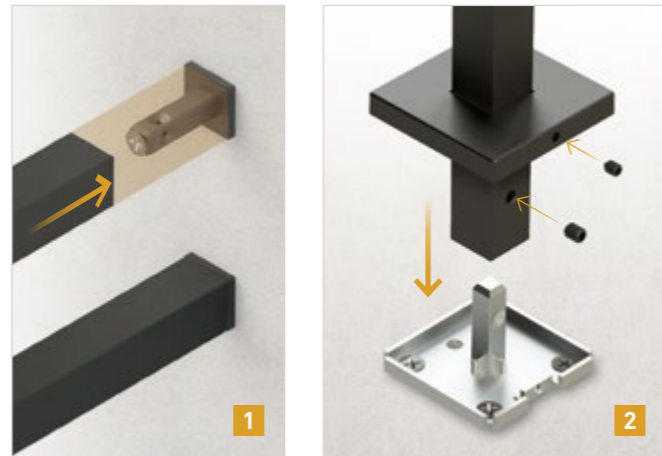

Wall / floor / ceiling attachment 83099.**** with clamp 83172.****

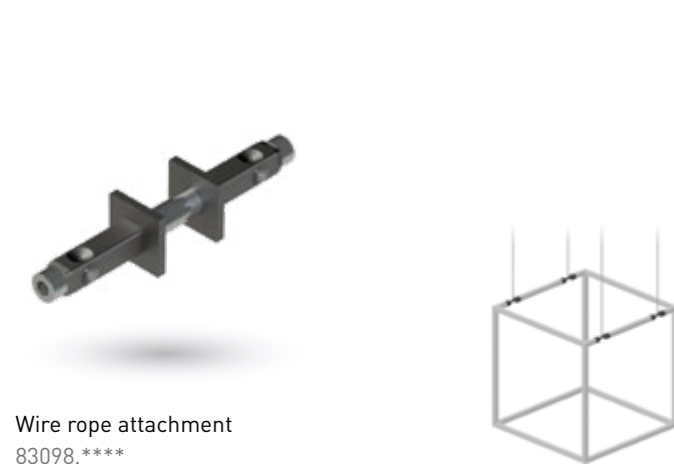
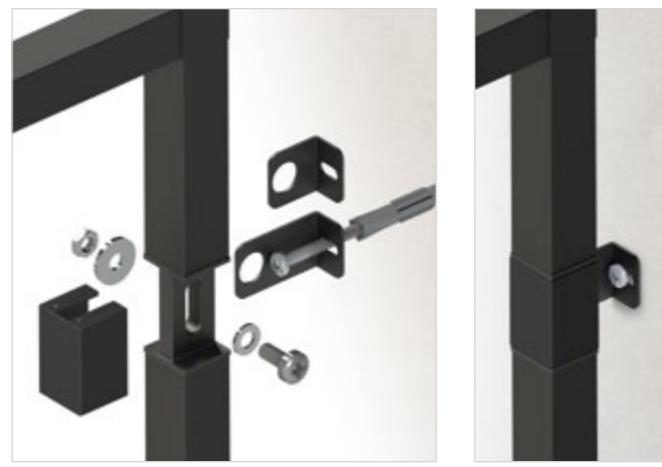

Wire rope attachment 83098.****



The display profiles.

Specially for the field of display design and fair booth construction, we have developed profiles which are intended to hold textile banners with circumferential flat welt. So CADRO allows not only to create single display and fair booth walls, but also to design complex advertising and exhibition objects.



The printed textile panels are provided with a circumferential flat welt which is inserted into the groove of the frame profile. Thus, the graphic is stretched tightly in the frame. Whether as a simple frame...

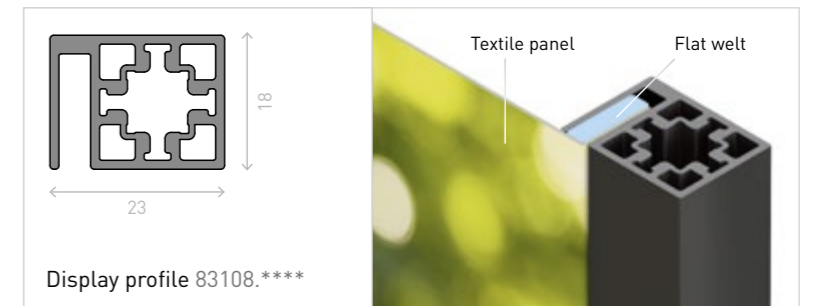

...as a corner solution...

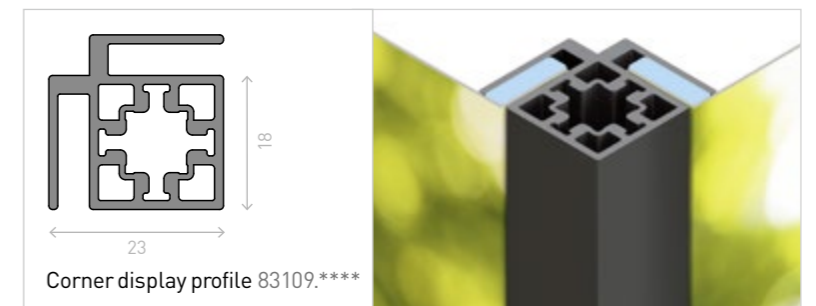

...or in order to connect large motifs. The display profiles offer possibilities for a large variety of applications. The objects can flexibly be designed, a change of the textile banner is very simple and can be done within a few minutes without tools.

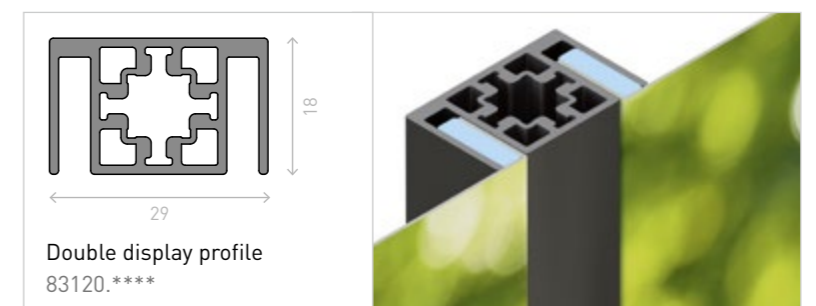

CADRO | Processing and technology

The creation of a CADRO element of furniture: technically simple and easy to handle.

Whether you do the assembling of your furniture completely by yourself, use measure made predrilled and/or premilled profiles or order the complete furniture element ready to use – You have the choice..

Working steps described on the example of smaller manufacturers:

Sawing.

Each profile can be cut to its required length using a standard table saw with an aluminium resistant saw blade.



Drilling and threading.

Afterwards the holes for the threads are drilled at standard distance to the profile's end. These are used to fasten the nodes.

The hole is being drilled with a standard 4,5mm drill. Afterwards screw in the M5 threaded screw using a cordless screwdriver. By doing this, the threaded pin cuts its own thread into the aluminum profile.

Thanks to generous tolerances processing is easy for everyone.



Milling.

For the invisible wall mounting a cutout is made on the back of the furniture element. This can be done with any commercially available milling machine. It is also possible to place our manufacturing aid on a milling machine for all manufacturing steps.

Finished! Thus, the basic concept of the CADRO system has already been explained and there will be no limits to your creativity anymore.



Manufacturing aid
82927.01.0000

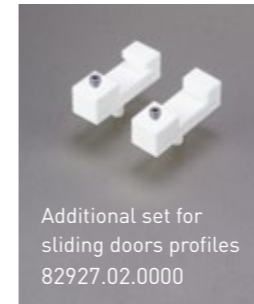

Additional set for sliding doors profiles
82927.02.0000



Additional set for display profiles
82927.03.0000

Tools.

The manufacturing aid.

With this device we offer you a technical aid for the precise drilling of holes and threads. The fastest and easiest way to drill and mill precise holes and cutouts. The dimensions of this extremely solid plastic block are exactly adapted to the CADRO System profiles with a base of 18 x 18 mm. Two additional sets including 2 complementary attachments each are available for the following profiles:

Additional set	For profile	Additional set	For profile
82927.02.000 (2x2 attachments)	82913.****/82915.****	82927.03.000 (3x2 attachments)	83108.****
	82914.****/82916.****		83109.****
	83104.****/83106.****		83120.****
	83105.****/83107.****		



Pillar drilling machine
82927.00.0000

Pillar drilling machine.

As a working tool, we recommend a pillar drilling machine with which you can easily do all drilling and threading work required for the CADRO system.

Do not hesitate to contact us, we will be glad to answer any further questions you may have regarding the CADRO frame system.















alternative...











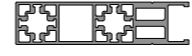

... we offer to deliver your order made-to-measure with predrilled and premilled profiles. Or you order your components of furniture made according to your specifications and we will then supply the completely assembled frame, all tailor-made for your requirements.

For further technical information, please refer to our additional booklet: CADRO – Technical information and assembly











CADRO Base – At a glance.

ART.NO.	Description	PU	Material	Colour
Basic Profiles				
	82792.**** Basic profile (3000 mm length)	10	Aluminium	****.0170 ****.0098 ****.0180
	82793.**** Profile for shelf panels (for 16 mm panels) (3000 mm length)	10	Aluminium	****.0170 ****.0098 ****.0180
	82794.**** Profile for glass panels (for 6 mm glass panels) (3000 mm length)	10	Aluminium	****.0170 ****.0098 ****.0180
	82975.**** Profile for side/shelf panels (for 16 mm panels) (3000 mm length)	10	Aluminium	****.0170 ****.0098 ****.0180
	82912.**** Profile for side/shelf panels (for 16 mm profiles, screw-connected) (3000 mm length)	10	Aluminium	****.0170 ****.0098 ****.0180
	83168.**** Profile for side/shelf panels (for 16 mm panels, screwable over the corner) (3000 mm length)	10	Aluminium	****.0170 ****.0098 ****.0180
	82914.**** Profile for sliding doors – External mounting, top (3000 mm length)	10	Aluminium	****.0170 ****.0098 ****.0180
	82913.**** Profile for sliding doors – External mounting, bottom (3000 mm length)	10	Aluminium	****.0170 ****.0098 ****.0180
	83105.**** Profile for sliding doors – External mounting, top (3000 mm length)	10	Aluminium	****.0170 ****.0098 ****.0180
	83104.**** Profile for sliding doors – External mounting, bottom (3000 mm length)	10	Aluminium	****.0170 ****.0098 ****.0180
	82916.**** Profile for sliding doors – Internal mounting, top (3000 mm length)	10	Aluminium	****.0170 ****.0098 ****.0180
	82915.**** Profile for sliding doors – Internal mounting, bottom (3000 mm length)	10	Aluminium	****.0170 ****.0098 ****.0180
	83107.**** Profile for sliding doors – Internal mounting, top (3000 mm length)	10	Aluminium	****.0170 ****.0098 ****.0180
	83106.**** Profile for sliding doors – Internal mounting, bottom (3000 mm length)	10	Aluminium	****.0170 ****.0098 ****.0180





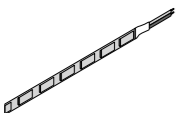







CADRO Base – At a glance.

ART.NO.	Description	PU	Material	Colour
Basic Profiles				
	83149.**** Basic profile for Hettich pull-out drawers (3000 mm length)	10	Aluminium	****.0170 ****.0098 ****.0180
	83150.**** L-shaped cover for Hettich pull-outs (3000 mm length)	10	Aluminium	****.0170 ****.0098 ****.0180
	83151.**** U-shaped cover for Hettich pull-outs (3000 mm length)			
	83177.**** Clips (for mounting cover 83150.**** and 83151.****)	300	Plastic	****.0001
Basic Connectors				
	82925.**** Double	48	Zamac	****.0033 ****.0067 ****.0174
	82932.**** Triple-2D	48	Zamac	****.0033 ****.0067 ****.0174
	82795.**** Triple-3D	48	Zamac	****.0033 ****.0067 ****.0174
	82796.**** Quadruple	48	Zamac	****.0033 ****.0067 ****.0174
	82797.**** Quintuple	48	Zamac	****.0033 ****.0067 ****.0174
Basic Connectors with stand				
	83058.**** Double (including adjustable stand, 5 mm height adjustment)	48	Zamac, steel, plastic	****.0033 ****.0067 ****.0174
	83119.**** Triple-2D (including adjustable stand, 5 mm height adjustment)	48	Zamac, steel, plastic	****.0033 ****.0067 ****.0174
	82948.**** Triple-3D (including adjustable stand, 5 mm height adjustment)	48	Zamac, steel, plastic	****.0033 ****.0067 ****.0174
	82949.**** Quadruple (including adjustable stand, 5 mm height adjustment)	48	Zamac, steel, plastic	****.0033 ****.0067 ****.0174

CADRO Lighting – At a glance.

ART.NO.	Description	PU	Material	Colour
Lighting profiles				
 82967.****	Basic lighting profile (3000 mm length)	10	Aluminium	****.0170 ****.0098 ****.0180
 82968.****	Lighting profile for shelf panels (for 16 mm panels) (3000 mm length)	10	Aluminium	****.0170 ****.0098 ****.0180
 82903.****	Diffusing profile/cable cover (3000 mm length)	10	PC	****.0000 ****.0001
 82969.****	Diffusing profile for shelf panels (3000 mm length)	10	PC	****.0000
Connectors for light cabling				
 83077.****	Triple for LED	48	Zamac	****.0033 ****.0067 ****.0174
 83078.****	Quadruple for LED	48	Zamac	****.0033 ****.0067 ****.0174
 83079.****	Quintuple for LED	48	Zamac	****.0033 ****.0067 ****.0174
 82974.****	Triple for power supply	48	Zamac	****.0033 ****.0067 ****.0174
LED ribbons – self-adhesive				
 45070.****	LED ribbon, warm white, 12V, power cable length 1,5 m 340 mm length, 2,6 W (for 400 mm CADRO furniture width 1 set = 5 pcs.)	1		****.3001
45069.****	540 mm length, 4,5 W (for 600 mm CADRO furniture width 1 set = 5 pcs.)			
45071.****	840 mm length, 6,5 W (for 900 mm CADRO furniture width 1 set = 4 pcs.)			
45072.****	1140 mm length, 9 W (for 1200 mm CADRO furniture width 1 set = 3 pcs.)			
 45074.****	Mini AMP plug	100	Plastic	****.0001



CADRO Glass display case – At a glance.

ART.NO.	Description	PU	Material	Colour
Profiles for CADRO Glass display case				
 83067.****	Angle profile for glass panels (3000 mm length)	10	Aluminium	****.0170 ****.0098 ****.0180
 83068.****	Double profile for glass panels (3000 mm length)	10	Aluminium	****.0170 ****.0098 ****.0180
 83070.****	Clip-on profile 2 glass panels 4 mm, 90° over the corner for 83067.**** (3000 mm length)	10	ABS	****.0233 ****.0235 ****.0234
 83071.****	Clip-on profile 1 glass panel 4 mm, 90° over the corner for 83067.**** (3000 mm length)	10	ABS	****.0233 ****.0235 ****.0234
 83072.****	Clip-on profile 1 glass panel 4 mm + support for glass panel 6 mm for 83067.**** (3000 mm length)	10	ABS	****.0233 ****.0235 ****.0234
 83073.****	Clip-on profile 2 glass panels 4 mm for 83068.**** (3000 mm length)	10	ABS	****.0233 ****.0235 ****.0234
 83161.****	Lighting clip-on profile 1 glass panel 4 mm, 90° over the corner for 83067.**** (3000 mm length)	10	PC	****.0239 ****.0240 ****.0241
 83160.****	Lighting clip-on profile 2 glass panels 4 mm, 90° over the corner for 83067.**** (3000 mm length)	10	PC	****.0239 ****.0240 ****.0241
 83085.****	Piping profile diam. = 3 mm, black 1 set = 1 bag incl. 50 pcs. à 25 mm	1	Silicone	****.0001
 83170.****	Sealing strip 2 mm, self-adhesive, black 1 roll = 50 m, incl. tweezer	1	Paper fleece, acrylic glue	****.0000
Connectors for CADRO Glass display case				
 83077.****	Triple	48	Zamac	****.0033 ****.0067 ****.0174
 83078.****	Quadruple	48	Zamac	****.0033 ****.0067 ****.0174
 83079.****	Quintuple	48	Zamac	****.0033 ****.0067 ****.0174







CADRO Glass display case – At a glance.

ART.NO.	Description	PU	Material	Colour
Accessories for CADRO Glass display case				
 83139.****	Glass door hinge set top/bottom	10	Zamac, steel, plastic	****.0033 ****.0067 ****.0174
 83141.****	Glass door lock set	10	Zamac, steel, plastic	****.0033 ****.0067 ****.0174
 83171.****	Ball spring plunger	10	Plastic	****.0001
 83142.****	Glass door handle attachment set	10	Zamac, steel, plastic	****.0033 ****.0067 ****.0174
 83143.****	Glass door door stop/shelf support	10	Steel, plastic	****.0001
 83140.****	Screw M5 x 4	200	Steel	****.0186



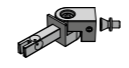
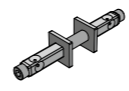
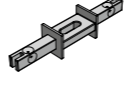
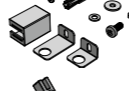
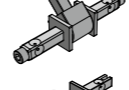
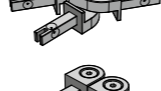
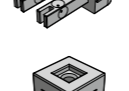





CADRO Room concept – At a glance.

ART.NO.	Description	PU	Material	Colour
Profiles for CADRO Room concept				
 83108.****	Display profile simple (3000 mm length)	10	Aluminium	****.0170 ****.0098 ****.0180
 83109.****	Corner display profile (3000 mm length)	10	Aluminium	****.0170 ****.0098 ****.0180
 83120.****	Double display profile (3000 mm length)	10	Aluminium	****.0170 ****.0098 ****.0180

CADRO Room concept – At a glance.

ART.NO.	Description	PU	Material	Colour
Connectors for CADRO Room concept				
 83115.****	Angle connector up to 180°	48	Zamac, steel	****.0033 ****.0067 ****.0174
 83116.****	Hinge connector up to 180°	48	Zamac, steel	****.0033 ****.0067 ****.0174
 83117.****	Screwable connector up to 180°	48	Zamac, steel	****.0033 ****.0067 ****.0174
 83098.****	Wire rope attachment	48	Zamac, steel	****.0033 ****.0067 ****.0174
 83099.****	Wall/floor/ceiling attachment	48	Zamac	****.0033 ****.0067 ****.0174
 83172.****	Clamp for wall attachment 83099.****	48	Zamac, steel	****.0033 ****.0067 ****.0174
 83118.****	Hinge connector up to 360°	48	Zamac, steel	****.0033 ****.0067 ****.0174
 83103.****	Cross hinge	48	Zamac, steel	****.0033 ****.0067 ****.0174
 83148.****	Connector up to 360°	48	Zamac, steel	****.0033 ****.0067 ****.0174
 83092.****	Universal connector	48	Zamac	****.0033 ****.0067 ****.0174
 83093.****	Connecting arm for universal connector 83092.**** (Set incl. cylinder screw)	48	Zamac, steel	****.0091
 83096.****	Wall/floor attachment	48	Zamac	****.0033 ****.0067 ****.0174
 83147.****	Wall/floor attachment	48	Zamac	****.0033 ****.0067 ****.0174



CADRO fixing material and accessories – At a glance.

ART.NO.	Description	PU	Material	Colour
Fixing material and accessories				
 82799.****	Wall mounting, 1 Set = 2 pcs. (including main fastening system, adjustment plate, screw, dowel, threaded pin in silver, stainless steel, black)	20	Zamac, steel	*****.0000 Zinc-plated
 82921.****	Fastening sleeve, 1 Set = 2 pcs. (to fix shelf panels at the bottom)	20	SUS 201	*****.0090
 82923.****	End cap for basic profile (for table feet, or similar)	100	PA 6	*****.0001 *****.0007
 82934.****	End cap for basic profile (to cover a profile, thin version)	100	ABS	*****.0001 *****.0067
 82931.****	Stand, 20 mm height adjustment, 1 Set = 2 pcs.	10	Steel, PA 6	*****.0000 Schwarz
 82938.****	Connecting thread, M8, 1 Set = 2 pcs.	10	PA 6	*****.0000 Schwarz
 82922.****	Cover cap, 1 Set = 2 pcs. (for 10 mm drill holes)	100	ABS	*****.0001 *****.0007
 82964.****	Cover cap (for M5 threaded pin)	1000	PP	*****.0001 *****.0007 *****.0225
 83044.****	Cover clip (for 4–6 mm drilling holes)	1000	PP	*****.0001
 82918.****	Threaded pin, M5 x 6 mm DIN 913	200	Steel	*****.0186 *****.0091 *****.0090
 82919.****	Threaded pin with secure glue, M5 x 6 mm DIN 913	200	Steel	*****.0186 *****.0091 *****.0090
 82936.****	Corner connector (invisible)	48	Zamac	*****.0091
 82937.****	Universal connector (invisible)	48	Zamac	*****.0091
 82939.****	Cylinder head screw with hexagon socket, M5 x 35 mm DIN 4762	200	Steel	*****.0000

CADRO fixing material and accessories – At a glance.

ART.NO.	Description	PU	Material	Colour
Fixing material and accessories				
 82942.****	Ball spring plunger	200	Steel	*****.0000
 82935.****	Felt pads, 1 Set = 25 pcs.	1	Felt	*****.0000
 83048.****	Door stop, 1 Set = 2 pcs.	100	Kunststoff	*****.0001 *****.0230
 83154.****	Handle "STRAIGHT"	50	Zamac	*****.0033 *****.0067 *****.0174
 56294.**** 56321.**** 56322.**** 56323.****	128 mm 160 mm 192 mm 320 mm Bar handle (Special length on demand)	100	Zamac, Aluminium	*****.0223 *****.0174

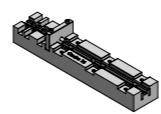
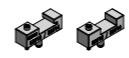
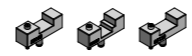
CADRO tools – At a glance.

ART.NO.	Description	PU	Material	Colour
Tools				
 82927.01.****	Manufacturing aid	1	PA	*****.0000
 82927.02.****	Additional set for sliding door profiles (2 attachments each for manufacturing aid 82927.01.0000)	1	PA	*****.0000
 82927.03.****	Additional set for display profiles (2 attachments each for manufacturing aid 82927.01.0000)	1	PA	*****.0000
 82927.00.****	Pillar drilling machine	1		*****.0000

Surfaces – At a glance.

Profiles

Material	Surfaces	Colour
Aluminium	 Black matt anodized	*****.0170
	 Silver matt anodized	*****.0098
	 Stainless steel matt brushed anodized	*****.0180
Plastic (Clip profiles)	 Plain black	*****.0001
	 Black matt embossed	*****.0233
	 Silver matt embossed	*****.0235
	 Stainless steel matt embossed	*****.0234
Plastic (Light diffusing profiles)	 Translucent	*****.0000
	 Black matt coated	*****.0239
	 Silver matt coated	*****.0240
	 Stainless steel matt coated	*****.0241

Connectors and accessories

Material	Surfaces	Colour
Zamac/ plastic	 Black supermatt painted	*****.0033
	 Silver matt painted	*****.0067
	 Stainless steel matt brushed painted	*****.0174
Plastic	 A2 Stainless steel	*****.0090
	 Steel bright, black	*****.0186
	 Zinc-plated	*****.0091
Plastic	 Grey RAL 7035	*****.0007
	 Grey RAL 7045	*****.0230
	 White aluminium RAL 9006	*****.0225
Other materials and surfaces		*****.0000

Additional colours available on demand. Please be aware that anodized surfaces may show slight colour discrepancies which are due to technical reasons.

Information.



Everything on hand!

For the presentation of our CADRO frame system, we have prepared a sample case including connectors, profile samples and accessories. This allows you to present CADRO to your customers and to convince them of the quality and flexibility of our system.

We are looking forward to receiving your order request.

For further technical information, please refer to our additional booklet: **CADRO – Technical information and assembly**



Delivery:

- Sold by the metre & single components
- Ready-made lengths
- Completely assembled frame elements

Contact:

confurn
 Sundernkämpe 14 | D-32549 Bad Oeynhausen
 Fon +49 5734 9609-0 | info@confurn.de
 www.confurn.de

