

| CADRO

CADRO

| Éléments d'éclairage



MINI PROJECTEUR LED À TIGE

45078.0170.4001

12 V, 3 W, 4000 K,
aluminium, noir supermatt,
câble de 1,5 m + fiche mini AMP inclus

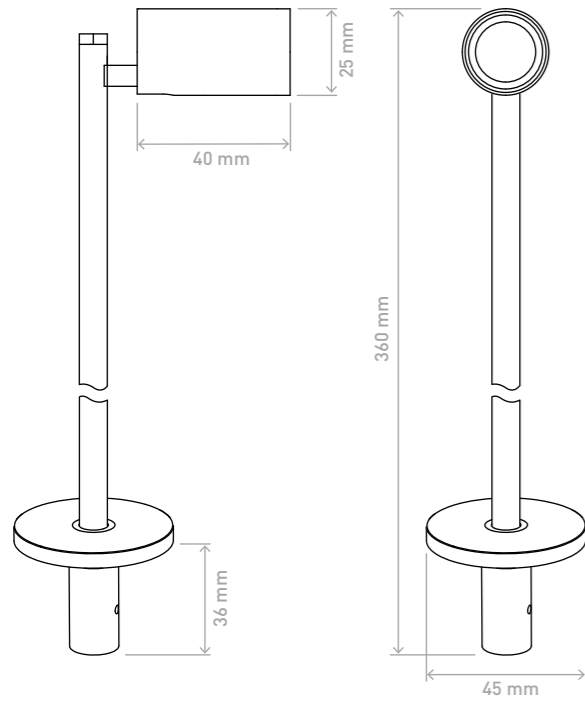

MINI PROJECTEUR LED ENCASTRABLE

45077.0170.4001

12 V, 3 W, 4000 K,
aluminium, noir supermatt,
câble de 1,5 m + fiche mini AMP inclus

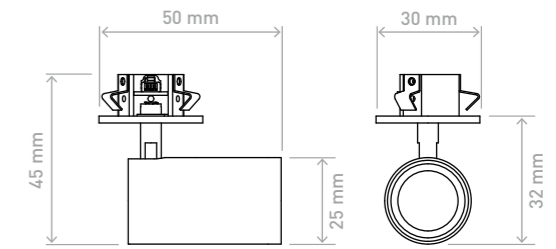

RAIL D'ALIMENTATION ROND

45079.0170

12 V, 3 m, aluminium, schwarz supermatt

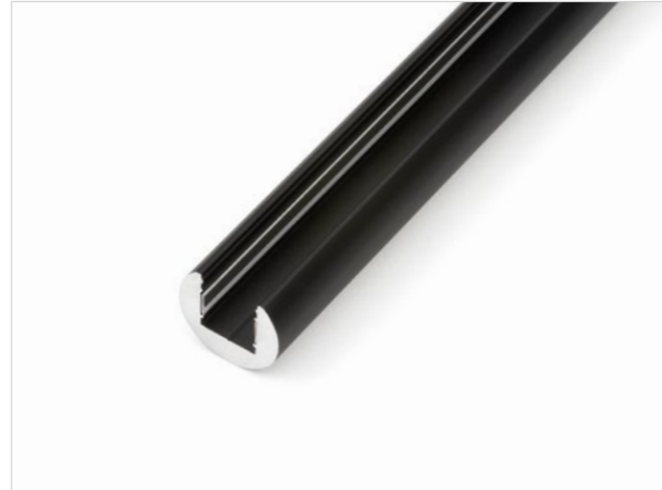
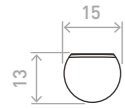

RAIL D'ALIMENTATION EN SAILLIE

45080.0170

12 V, 3 m, aluminium, noir supermatt

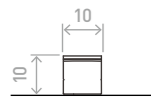

RAIL D'ALIMENTATION ENCASTRÉ

45081.0170

12 V, 3 m, aluminium, noir supermatt

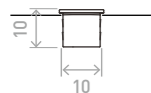

APPLICATIONS POSSIBLES

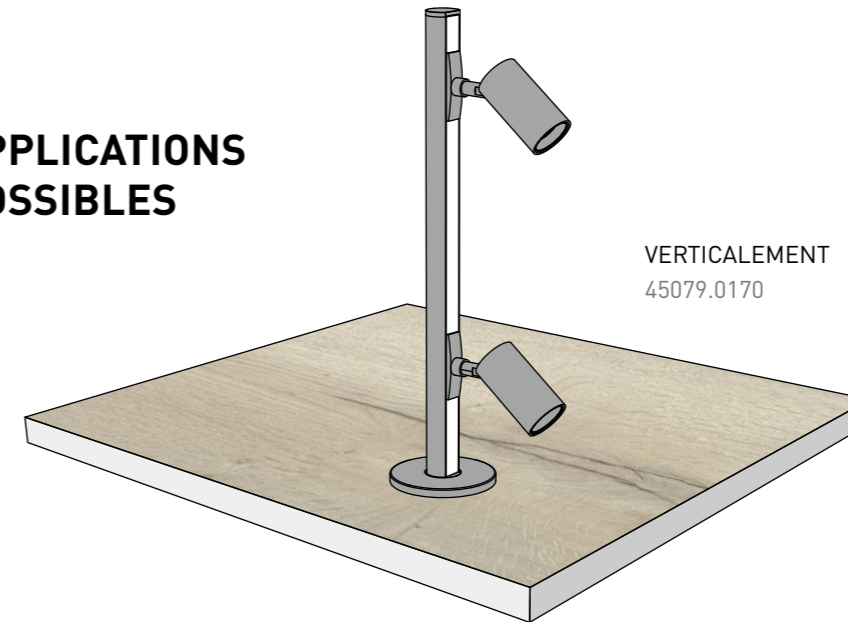

VERTICALEMENT
45079.0170

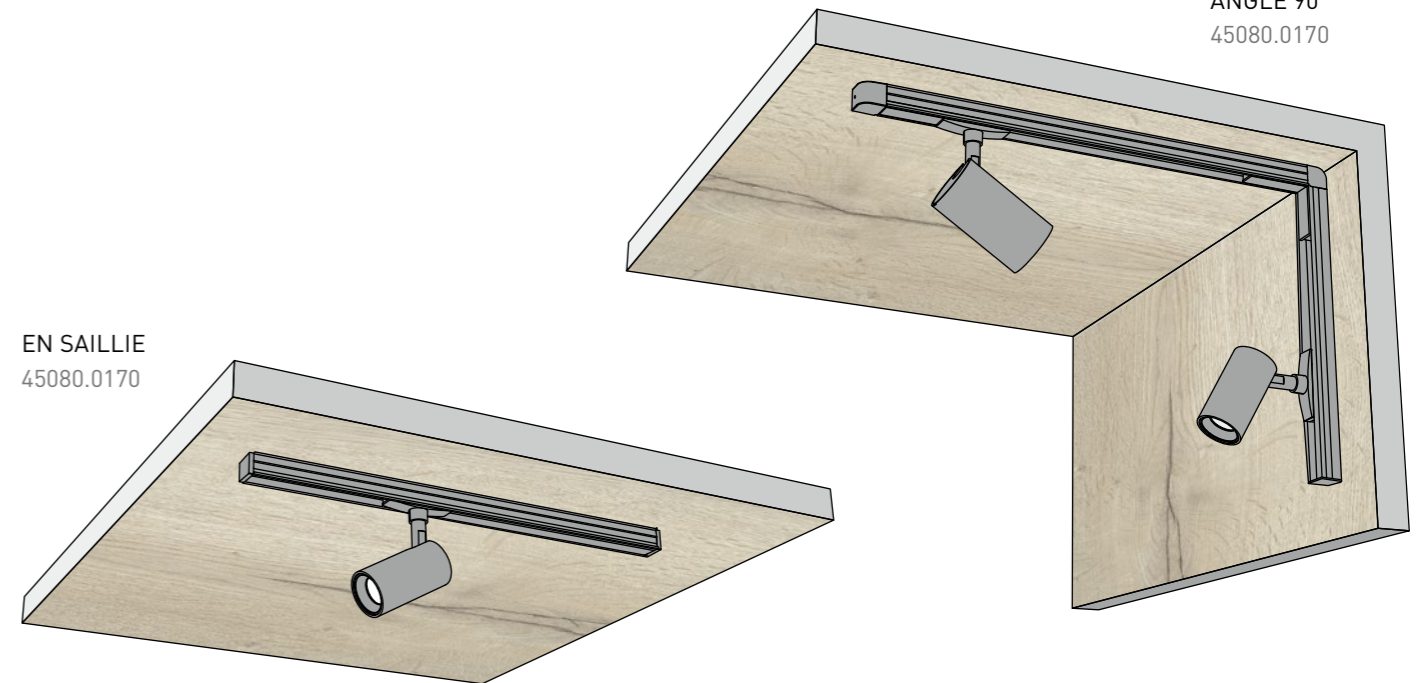

EN SAILLIE
ANGLE 90°
45080.0170

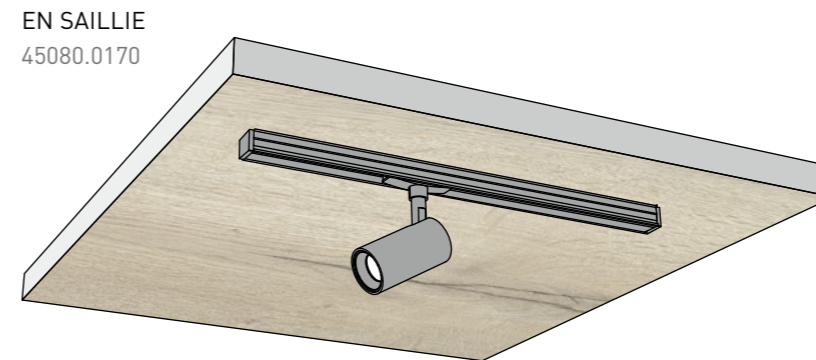

EN SAILLIE
45080.0170

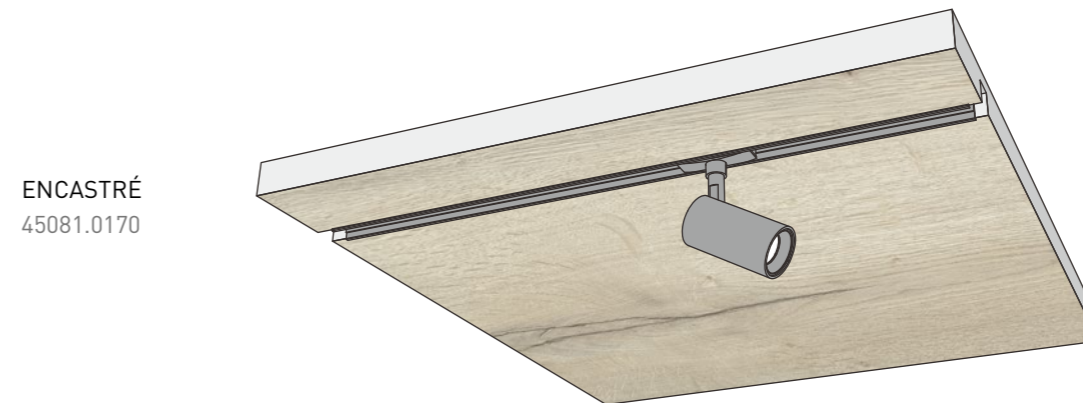

ENCASTRÉ
45081.0170

PROFIL DIFFUSEUR

45086.0000

3 m, matière plastique, blanc opalin



PROFIL DE RECouvreMENT

45087.0001

3 m, matière plastique, noir mat



CABLE D'ACCES

45089.0000

1,5 m, noir,
fiche Mini AMP inclus



Tous les rails d'alimentation sont activés en connectant le câble d'accès. Les spots peuvent ainsi être insérés à n'importe quel endroit dans les profils. En outre, le câble d'accès sert à connecter des bandes lumineuses LED qui peuvent être collées dans les profils d'éclairage pour un éclairage des surfaces.

MINI PROJECTEUR À LED 1W

45075.0170.3001

12 V, 1 W, 80 lm, 3000 K,
aluminium/plastique, noir supermat,
à enficher dans les rails d'alimentation

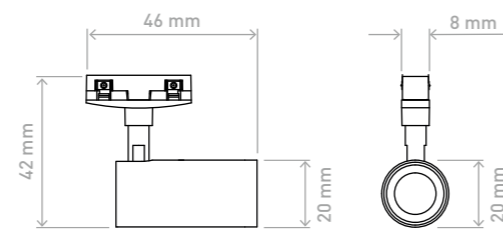

MINI PROJECTEUR À LED 3W

45076.0170.3001

12 V, 3 W, 240 lm, 3000 K,
aluminium/plastique, noir supermat,
à enficher dans les rails d'alimentation

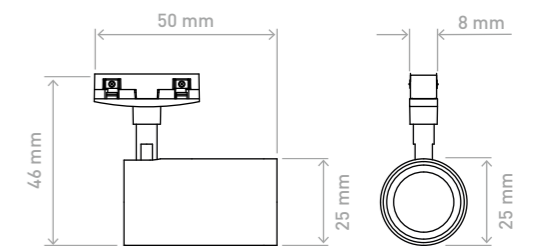
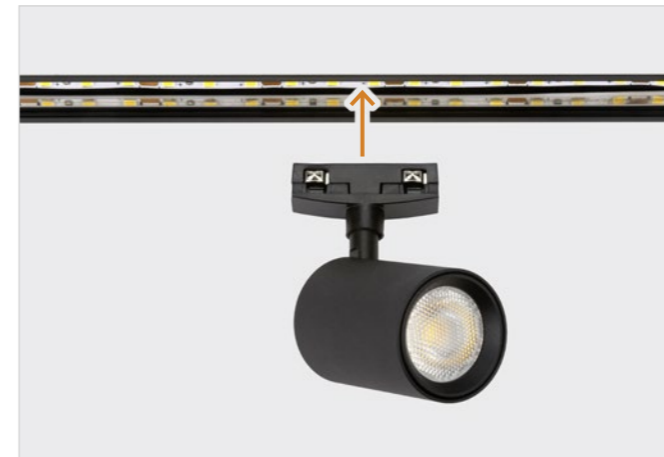

SOCLE DE FIXATION POUR RAIL D'ALIMENTATION ROND

45085.0170

Aluminium,
noir supermatt



EMBOUT POUR RAIL D'ALIMENTATION ROND

45082.0001

Plastique,
noir supermatt



EMBOUT POUR RAIL D'ALIMENTATION ENCASTRÉ

45083.0001

Plastique,
noir supermatt

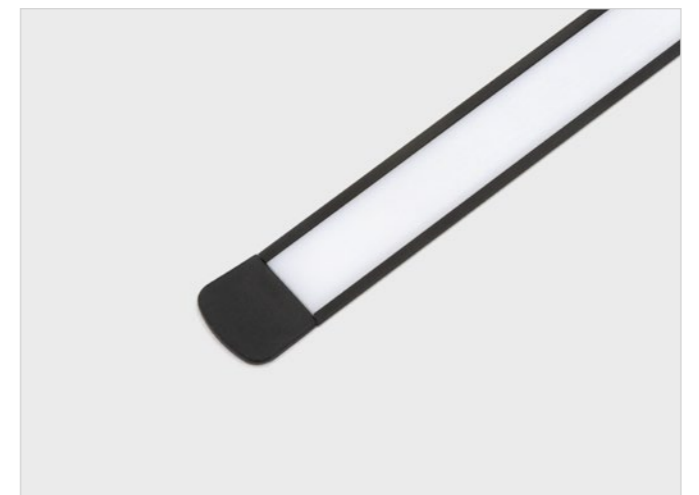

KITS D'EMBOUTS POUR RAIL D'ALIMENTATION EN SAILLIE

45084.0001

Plastique,
noir supermatt

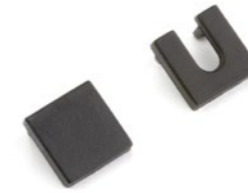

CLIPS DE FIXATION, KIT DE 2 PIÈCES POUR RAIL D'ALIMENTATION EN SAILLIE

45088.0000

Métal



RACCORD D'ANGLE

45091.0001

Plastique,
noir supermatt



CÂBLE DE CONNEXION

45090.0000

70 mm, noir

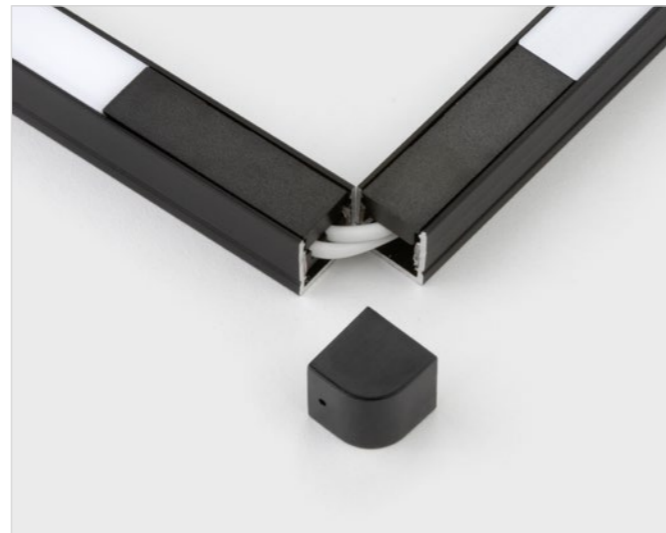

BANDE LUMINEUSE SMD 4,8 W

45092.3001

12 V, 4,8 W/m, 60 LED/m,
blanc chaud 3000 K,
5 mm x 5 m



BANDE LUMINEUSE SMD 9,6 W

45093.3001

12 V, 9,6 W/m, 120 LED/m,
blanc chaud 3000 K,
5 mm x 5 m













BANDE LUMINEUSE SMD 5 W

45094.2760











12 V, 5 W/m, 152 LED/m,
2700 - 6000 K,
5 mm x 5 m



CADRO | Éléments d'éclairage - en un coup d'œil

	Art. No.	Description	UE
	45075.0170.3001	MINI PROJECTEUR À LED 1W 12 V, 1 W, 80 lm, 3000 K, aluminium/plastique, noir supermat, à enficher dans les rails d'alimentation	10
	45076.0170.3001	MINI PROJECTEUR À LED 3W 12 V, 3 W, 240 lm, 3000 K, aluminium/plastique, noir supermat, à enficher dans les rails d'alimentation	10
	45077.0170.4001	MINI PROJECTEUR À LED ENCASTRABLE 12 V, 3 W, 4000 K, aluminium, noir supermat, câble de 1,5 m + fiche mini AMP inclus	10
	45078.0170.4001	MINI PROJECTEUR LED À TIGE 12 V, 3 W, 4000 K, aluminium, noir supermat, câble de 1,5 m + fiche mini AMP inclus	10
	45079.0170	RAIL D'ALIMENTATION ROND 12 V, 3 m, aluminium, noir supermat	10
	45080.0170	RAIL D'ALIMENTATION EN SAILLIE 12 V, 3 m, aluminium, noir supermat	10
	45081.0170	RAIL D'ALIMENTATION ENCASTRÉ 12 V, 3 m, aluminium, noir supermat	10
	45082.0001	EMBOUT POUR RAIL D'ALIMENTATION ROND Plastique, noir supermatt	100
	45083.0001	EMBOUT POUR RAIL D'ALIMENTATION ENCASTRÉ Plastique, noir supermatt	100
	45084.0001	EMBOUTS POUR RAIL D'ALIMENTATION EN SAILLIE, 1 KIT=2 PIÈCES Plastique, noir supermatt	100

CADRO | Éléments d'éclairage - en un coup d'œil

	Art. No.	Description	UE
	45085.0170	SOCLE DE FIXATION POUR RAIL D'ALIMENTATION ROND Aluminium, noir supermat	10
	45086.0000	PROFIL DIFFUSEUR 3 m, plastique, blanc opalin	10
	45087.0001	PROFIL DE RECOUVREMENT 3 m, plastique, noir mat	10
	45088.0000	CLIPS DE FIXATION POUR RAIL D'ALIMENTATION EN SAILLIE, 1 KIT=2 PIÈCES Métal	100
	45089.0000	CÂBLE D'ACCÈS 1,5 m, noir, connecteur Mini AMP inclus	10
	45090.0000	CÂBLE DE CONNEXION 70 mm, noir	10
	45091.0001	RACCORD D'ANGLE Plastique, noir supermatt	100
	45092.3001	BANDE LUMINEUSE SMD 4,8 W 12 V, 4,8 W/m, 60 LED/m, blanc chaud 3000 K, 5 mm x 5 mm	5
	45093.3001	BANDE LUMINEUSE SMD 9,6 W 12 V, 9,6 W/m, 120 LED/m, blanc chaud 3000 K, 5 mm x 5 mm	5
	45094.2760	BANDE LUMINEUSE SMD 5 W 12 V, 5 W/m, 152 LED/m, 2700 - 6000 K, 5 mm x 5 mm	5

